

Silicon Investigations  
Repair Information - Contact Us  
920-955-3693  
www.siliconinvestigations.com

Agilent Technologies  
**8922 Multi-Band Test System**  
**Supplementary**  
**User's Guide**

Systems Covered

HP/Agilent 8922P Multi-Band Test System  
HP/Agilent 8922R Multi-Band Test System  
HP/Agilent 8922X Multi-Band Test System  
HP/Agilent 8922Y Multi-Band Test System



**Agilent Part No. 08922-90226**  
**Printed in UK**  
**October 1998**



---

## Warranty

This Agilent Technologies instrument product is warranted against defects in material and workmanship for a period of one year from date of shipment. During the warranty period, Agilent Technologies will at its option, either repair or replace products which prove to be defective.

For warranty service or repair, this product must be returned to a service facility designated by Agilent Technologies. Buyer shall prepay shipping charges to Agilent Technologies and Agilent Technologies shall pay shipping charges, duties, and taxes for products returned to Agilent Technologies from another country.

Agilent Technologies warrants that its software and firmware designated by Agilent Technologies for use with an instrument will execute its programming instructions when properly installed on that instrument. Agilent Technologies does not warrant that the operation of the instrument, or software, or firmware will be uninterrupted or error free.

---

## Limitation of Warranty

The foregoing warranty shall not apply to defects resulting from improper or inadequate maintenance by Buyer, Buyer-supplied software or interfacing, unauthorized modification or misuse, operation outside of the environmental specifications for the product, or improper site preparation or maintenance.

NO OTHER WARRANTY IS EXPRESSED OR IMPLIED. AGILENT TECHNOLOGIES SPECIFICALLY DISCLAIMS THE IMPLIED WARRANTIES OF MERCHANTABILITY AND FITNESS FOR A PARTICULAR PURPOSE.

---

## Limitation of Remedies and Liability

THE REMEDIES PROVIDED HEREIN ARE BUYER'S SOLE AND EXCLUSIVE REMEDIES. AGILENT TECHNOLOGIES SHALL NOT BE LIABLE FOR ANY DIRECT, INDIRECT, SPECIAL, INCIDENTAL, OR CONSEQUENTIAL DAMAGES, WHETHER BASED ON CONTRACT, TORT, OR ANY OTHER LEGAL THEORY.

---

### Responsibilities of the Customer

The customer shall provide;

- 1 Access to the products during the specified periods of coverage to perform maintenance.
- 2 Adequate working space around the products for servicing by Agilent Technologies personnel.
- 3 Access to and use of all information and facilities determined necessary by Agilent Technologies to service and/or maintain the products. (In so far as these items may contain proprietary or classified information, the customer shall assume full responsibility for safeguarding and protection from wrongful use.)
- 4 Routine operator maintenance and cleaning as specified in the Agilent Technologies Operating and Service Manuals.
- 5 Consumables such as paper, disks, magnetic tapes, ribbons, inks, pens, gases, solvents, lamps, filters, fuses, seals, etc.

---

### Certification

Agilent Technologies certifies that this product met its published specifications at the time of shipment from the factory. Agilent Technologies further certifies that its calibration measurements are traceable to the United States National Bureau of Standards and Technology, to the extent allowed by the Bureau's calibration facility, and to the calibration facilities of other International Standards Organization members.

---

### Assistance

Product maintenance agreements and other customer assistance agreements are available for Agilent Technologies products.

For any assistance, contact your local Agilent Technologies Sales and Service Office. For a list of contact information, see "Sales and Service Offices" on page 79i.

---

## Notices

The material contained in this document is subject to change without notice. AGILENT TECHNOLOGIES MAKES NO WARRANTY OF ANY KIND WITH REGARD TO THIS MATERIAL, INCLUDING, BUT NOT LIMITED TO, THE IMPLIED WARRANTIES OF MERCHANTABILITY AND FITNESS FOR A PARTICULAR PURPOSE. Agilent Technologies shall not be liable for errors contained herein or for incidental or consequential damages in connection with the furnishing, performance or use of this material.

Agilent Technologies assumes no responsibility for the use or reliability of its software on equipment that is not furnished by HP.

---

## Restricted Rights Legend

If Software is for use in the performance of a U.S. Government prime contract or subcontract, Software is delivered and licensed as "Commercial computer software" as defined in DFAR 252.227-7014 (June 1995), or as a "commercial item" as defined in FAR 2.101(a) or as "Restricted computer software" as defined in FAR 52.227-19 (June 1987) or any equivalent agency regulation or contract clause. Use, duplication or disclosure of Software is subject to Agilent Technologies' standard commercial licenseterms, and non-DOD Departments and Agencies of the U.S. Government will receive no greater than Restricted Rights as defined in FAR 52.227- 19(c)(1-2) (June 1987). U.S. Government users will receive no greater than Limited Rights as defined in FAR 52.227-14 (June 1987) or DFAR 252.227-7015 (b)(2) (November 1995), as applicable in any technical data. Copyright 200X Agilent Technologies Inc. All Rights Reserved.

---

## Statement of Compliance

This product conforms to EN61010-1(1993) / IEC 1010-1(1990) +A1(1992) +A2(1994) / CSA C22.2 No. 1010.1(1993) Safety requirements for Electrical Equipment for Measurement, Control and Laboratory Use, and has been supplied in a safe condition. The instruction documentation contains information and warnings which must be followed by the user to ensure safe operation and to maintain the instrument in a safe condition.

---

## Electromagnetic Compatibility (EMC) Information

This product has been designed to meet the protection requirements of the European Communities Electromagnetic Compatibility (EMC) directive:

EN55011:1991 (Group 1, Class A)

EN50082-1:1992

- IEC 1000-4-2 (1995) ESD

- IEC 1000-4-3 (1995) Radiated Susceptibility

- IEC 1000-4-4 (1995) EFT

In order to preserve the EMC performance of this product, any cable which becomes worn or damaged, must be replaced with the same type and specification.

---

## Sound Emission

### Manufacturer's Declaration

This statement is provided to comply with the requirements of the German Sound Emission Directive, from 18 January 1991.

This product has a sound pressure emission (at the operator position) < 70 dB(A).

- Sound Pressure  $L_p < 70$  dB(A).
- At Operator Position.
- Normal Operation.
- According to ISO 7779:1988/EN 27779:1991 (Type Test).

---

## Herstellerbescheinigung

Diese Information steht im Zusammenhang mit den Anforderungen der Maschinenlärminformationsverordnung vom 18 Januar 1991.

- Schalldruckpegel  $L_p < 70$  dB(A).
- Am Arbeitsplatz.
- Normaler Betrieb.
- Nach ISO 7779:1988/EN 27779:1991 (Typprüfung).

---

## Declaration of Conformity

according to ISO/IEC Guide 22 and EN45014

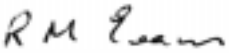
|   |   |
|---|---|
| <b>Manufacturer's Name:</b>   | <b>Agilent Technologies</b>   |
| <b>Manufacturer's Address:</b>  | South Queensferry<br>West Lothian, EH30 9TG<br>Scotland, United Kingdom   |
| Declares that the product   |   |
| <b>Product Name:</b>  | GSM MS Multi-Band Test Set  |
| <b>Model Numbers:</b>   | Agilent Technologies 8922P, 8922R, 8922X, 8922Y   |
| <b>Product Options:</b>   | This declaration covers all options of the above products as detailed in TCF A-5951-9852-02   |
| Conforms with the protection requirements of European Council Directive 89/336/EEC on the approximation of the laws of the member states relating to electromagnetic compatibility. |   |
| Against EMC test specifications EN 55011:1991 (Group 1, Class A) and EN 50082-1:1992  |   |
| <b>As Detailed in:</b>  | Electromagnetic Compatibility (EMC)<br>Technical Construction File (TCF) No. A-5951-9852-02   |
| <b>Assessed by:</b>   | Dti Appointed Competent Body<br>EMC Test Centre, GEC-Marconi Avionics Ltd.,<br>Maxwell Building, Donibristle Industrial Park,<br>KY11 5LB<br>Scotland, United Kingdom |
| Technical Report Number:6893/2200/CBR, dated 23 September 1997  |   |
| <b>Supplementary Information:</b>   |   |
| The product conforms to the following safety standards:   | EN 61010-1(1993) / IEC 1010-1(1990) +A1(1992) +A2(1994)<br>CSA-C22.2 No. 1010.1-93<br>EN 60825-1(1994) / IEC 825-1(1993)  |
| The product herewith complies with the requirements of the Low Voltage Directive 73/23/EEC, and carries the CE-marking accordingly.   |   |
| <b>South Queensferry, Scotland</b>  | <b>18 November 1997</b>   |
| <i>Location</i>   | <i>Date</i> <span style="float: right;"><i>R.M. Evans / Quality Manager</i></span>  |

---

## Safety Information

The following safety precautions must be observed during all phases of operation, service, and repair of this instrument. Failure to comply with these precautions or with specific warnings elsewhere in this manual violates safety standards of design, manufacture, and intended use of the instrument. Agilent Technologies Inc. assumes no liability for the customer's failure to comply with these requirements.

---

**WARNING:**

---

**This is a Safety Class I instrument (provided with a protective earthing ground, incorporated in the power cord). The mains plug shall only be inserted in a socket outlet provided with a protective earth contact. Any interruption of the protective conductor inside or outside of the instrument is likely to make the instrument dangerous. Intentional interruption is prohibited.**

DO NOT operate the product in an explosive atmosphere or in the presence of flammable gasses or fumes.

DO NOT use repaired fuses or short-circuited fuseholders: For continued protection against fire, replace the line fuse(s) only with fuse(s) of the same voltage and current rating and type.

DO NOT perform procedures involving cover or shield removal unless you are qualified to do so: Operating personnel must not remove equipment covers or shields. Procedures involving the removal of covers and shields are for use by service-trained personnel only.

DO NOT service or adjust alone: Under certain conditions, dangerous voltages may exist even with the equipment switched off. To avoid dangerous electrical shock, service personnel must not attempt internal service or adjustment unless another person, capable of rendering first aid and resuscitation, is present.









DO NOT operate damaged equipment: Whenever it is possible that the safety protection features built into this product have been impaired, either through physical damage, excessive moisture, or any other reason, REMOVE POWER and do not use the product until safe operation can be verified by service-trained personnel. If necessary, return the product to an Agilent Technologies Sales and Service Office for service and repair to ensure the safety features are maintained.

DO NOT substitute parts or modify equipment: Because of the danger of introducing additional hazards, do not install substitute parts or perform any unauthorized modification to the product. Return the product to an Agilent Technologies Sales and Service Office for service and repair to ensure the safety features are maintained.

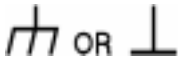

## Safety Symbols

The following symbols on the instrument and in the manual indicate precautions which must be taken to maintain safe operation of the instrument

| <b>Safety Symbols</b>   |   |
|---|---|
|    | The Instruction Documentation Symbol. The product is marked with this symbol when it is necessary for the user to refer to the instructions in the supplied documentation.  |
|    | Indicates the field wiring terminal that must be connected to earth ground before operating the equipment - protects against electrical shock in case of fault.   |
|    | Frame or chassis ground terminal - typically connects to the equipment's metal frame.   |
|   | Alternating current (AC)  |
|  | Direct current (DC)   |
|  | Indicates hazardous voltages.   |
| <b>WARNING</b>  | Warning denotes a hazard. It calls attention to a procedure, which if not correctly performed or adhered to could result in injury or loss of life. Do not proceed beyond a warning note until the indicated conditions are fully understood and met.                     |
| <b>CAUTION</b>  | Caution denotes a hazard. It calls attention to a procedure, which if not correctly performed or adhered to could result in damage to or destruction of the instrument. Do not proceed beyond a warning note until the indicated conditions are fully understood and met. |
|  | The CE mark shows that the product complies with all relevant European Legal Directives.  |
| <b>ISM 1-A</b>  | This is a symbol of an Industrial, Scientific, and Medical Group 1 Class A product.   |
|  | The CSA mark is a registered trademark of the Canadian Standards Association, and indicates compliance to the standards defined by them.  |
|  | Indicates that a laser is fitted. The user must refer to the manual for specific Warning or Caution information to avoid personal injury or damage to the product.  |

---

## About this Guide

### Overview

This User's Guide is a supplement to the Manuals currently supplied with the HP/Agilent 8922 GSM Test Sets. The information contained in this User's Guide is only relevant to the additional features of the Multi-Band Test System. For more information on the HP/Agilent 8922 and HP/Agilent 83220, refer the following Guides;

- Agilent 8922M/S User's Guide*
- Agilent 8922M/S Programming Reference Guide*
- Agilent 83220A/E User's Guide*

### Systems Covered

The following table details the product options and HP/Agilent 8922 Multi-Band Test Systems covered by this User's Guide.

| Multi-Band System Types Covered |  |  |  |  |
|---------------------------------|--|--|--|--|
|                                 | HP/Agilent<br>8922P                              | HP/Agilent<br>8922R                              | HP/Agilent<br>8922X                              | HP/Agilent<br>8922Y                              |
| Required Options                | 8922M<br>Option 010<br>+<br>83220E<br>Option 010 | 8922S<br>Option 010<br>+<br>83220E<br>Option 010 | 8922M<br>Option 010<br>+<br>83220A<br>Option 010 | 8922S<br>Option 010<br>+<br>83220A Option<br>010 |

### User's Guide - Abbreviations

For clarity, and unless otherwise stated, the following abbreviations will be used;

**HP/Agilent 8922M/S Option 010** This will be abbreviated to HP/Agilent 8922

**HP/Agilent 83220A/E Option 010** This will be abbreviated to HP/Agilent 83220

---

## Contents

About this Guide viii

### **1 Configuring the HP/Agilent 8922 Multi-Band Test System 1**

Before You Start 2

Connection Overview 3

Connection Details 4

Calibration Routine 7

Zero the Power Meter 9

### **2 How to Section 13**

Power-up and Operating Mode Selection 14

Establishing a Call 15

Making Measurements in the E-GSM900 Band 16

Changing Band 17

Making Measurements in the DCS1800 Band 19

Ending A Call 20

### **3 Screens 21**

Cell Configuration Screen 22

Cell Status Screen - Active Cell 23

Cell Status Screen - Test Mode 24

Configure Screen 25

Dual Band Control Screen 26

Error and Help Screens 31

MS Information/Signaling Screen 32

---

## Contents

- 4 GPIB Commands 33**
  - Additional Commands to existing subsystems 34
  - Dual Band Control Subsystem 36
  - GPIB Programming Example Overview 39
  - Example 40
  - GPIB Commands for Including Power Zeroing in an Automatic Test Routine 44
  
- 5 System Specifications 45**
  - Supplemental Characteristics (*shown in italics*) 46
  - GSM Functionality Specifications 47
  - RF Generator Specifications 48
  - 10 MHz to 1 GHz Aux RF Out Connector Specifications 50
  - 1710 to 1990 MHz Aux RF Out Connector Specifications (HP/Agilent 83220A only) 51
  - 0.3 GMSK Modulation Specifications 52
  - Pulse Modulation Specifications 53
  - 30 dB Pulse Modulation Specifications (Agilent 8922M Only) 54
  - RF Analyzer Specifications 55
  - CW RF Frequency Measurement Specifications 56
  - CW RF Power Measurement Specifications (RF in/out) only 57
  - Peak Transmitter Carrier Power Measurement Specifications (RF in/out) only 58
  - Pulse on/off Ratio Measurement Specifications (requires option 006) 60
  - Amplitude Envelope Measurement Specifications 61
  - Phase and Frequency Measurement Specifications 62

---

## Contents

|   |           |
|---|-----------|
| 0.3 GMSK Data Recovery Specifications (Agilent 8922M only)          | 63        |
| FM Demodulation Output Specifications (Agilent 8922M only)          | 64        |
| Pulse Demodulation Output Specifications (Agilent 8922M only)       | 65        |
| Output RF Spectrum Measurement Specifications (requires option 006) | 66        |
| Spectrum Analyzer Specifications<br>(requires option 006)           | 67        |
| Audio Source Specifications   | 68        |
| Audio Analyzer Specifications                                       | 69        |
| Oscilloscope Specifications   | 71        |
| Remote programming  | 72        |
| Printer Support   | 73        |
| General Specifications  | 74        |
| Reference Specifications  | 75        |
| <br>  |           |
| <b>6 How To Return Equipment for Repair</b>                         | <b>77</b> |
| Return Procedure  | 78        |
| Sales and Service Offices   | 79        |
| <br>  |           |
| <b>7 Appendix A - Establishing Absolute GSM BCH Power Level</b>     | <b>81</b> |
| Procedure   | 82        |

---

## Contents

---

## **Configuring the HP/Agilent 8922 Multi-Band Test System**

This section provides information on connecting and setting up of the HP/Agilent 8922 Multi-Band Test System.

---

## Before You Start

Before connecting the HP/Agilent 8922 or HP/Agilent 83220 to each other or to the line (mains) voltage, ensure you have read and familiarized yourself with the section, *Installing Your HP/Agilent 83220A/E*, in the *Agilent 83220A/E User's Guide*.

---

**WARNING:**

The HP/Agilent 8922 and HP/Agilent 83220 are Safety Class 1 products (provided with a protective earth terminal). A safety earth ground must be provided from the mains power source to the product input wiring terminals, power cord, or supplied power cord set. Whenever it is likely that the protection has been impaired, the HP/Agilent 8922 Multi-Band Test System must be made inoperative and be secured against any unintended operation.

---

**WARNING:**

If the HP/Agilent 8922 or HP/Agilent 83220 are to be energized by means of an external autotransformer for voltage reduction, make sure that the common terminal is connected to the neutral pole of the power source.

---



---

## Connection Overview

Connecting the HP/Agilent 8922 to the HP/Agilent 83220 is very similar to connecting a Standard HP/Agilent 8922 Test System. The main difference being that an additional cable is used between the HP/Agilent 8922 and the HP/Agilent 83220. Testing of mobiles in all bands is now carried out from a single port on the HP/Agilent 83220.

To configure the HP/Agilent 8922 Multi-Band Test System for making measurements, there are three main stages;

- 1 Connect the HP/Agilent 8922 to the HP/Agilent 83220. Refer to 'Connection Details' on page 4 and onwards for more information.
- 2 Carry out a system calibration process. Refer to 'Calibration Routine' on page 7 onwards for more information.
- 3 Zero the power meter. Refer to 'Zero the Power Meter' on page 9 for more information.

---

**NOTE:**

If the HP/Agilent 8922 and the HP/Agilent 83220 are not connected properly an error message will appear during power-up. Check all connections and switch the HP/Agilent 8922 off and then on again. If the error message still appears contact your local sales and service office for more assistance.

---

For additional information about connections and setting up, refer to the appropriate sections in the *Agilent 8922M/S User's Guide* and the *Agilent 83220A/E User's Guide*

---

## Connection Details

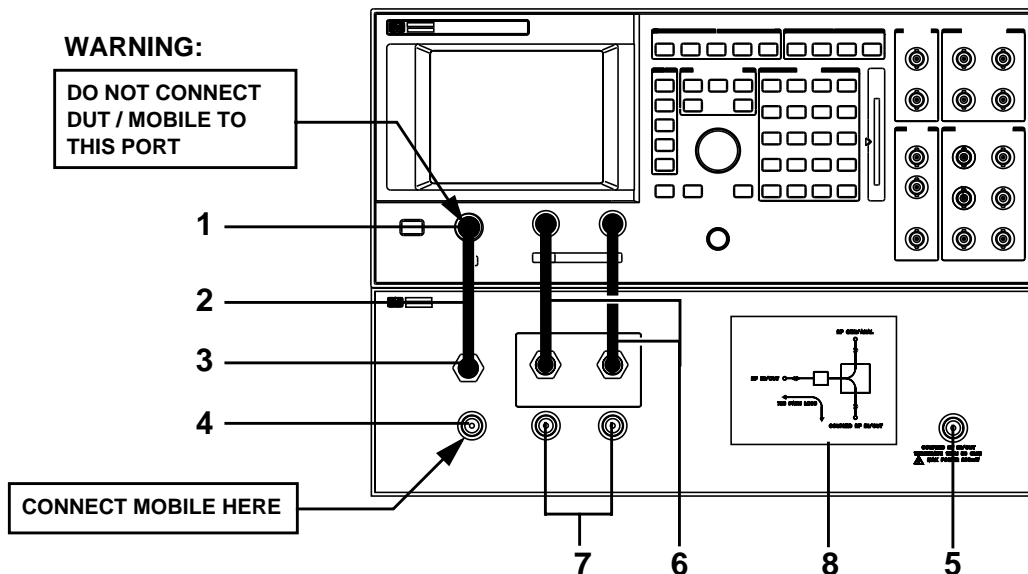

### 1. HP 8922 IF Link Port

The main port connecting the HP/Agilent 8922 to the HP/Agilent 83220. This port is used for providing the E-GSM900 and GSM900 link between the HP/Agilent 8922 and the HP/Agilent 83220.

---

**WARNING:**

Do not connect the device-under-test (DUT) to this port as this could seriously damage the HP/Agilent 8922.

### 2. IF Link Cable

The cable that connects the Agilent 8922 and HP/Agilent 83220 IF Link Ports.

### 3. HP/Agilent 83220 IF Link Port

The main port that connects the HP/Agilent 8922 and HP/Agilent 83220. See 1 above.

#### 4. GSM/DCS/PCS RF In/Out Port

This is the main device-under-test (DUT) connection port.

---

**NOTE:**

---

Maximum power:  
DCS1800 and PCS1900: 2 W, 15 W peak.  
GSM900 and E-GSM900: 8 W average.

#### 5. Coupled RF In/Out

The port that connects back to the main RF In/Out port. There is a nominal loss of 7 dB between this port and the main RF In/Out port. This port can be used for;

- Inserting adjacent cell BCH signals for monitoring by the mobile.
- Co-channel interference measurements.
- Connecting to an external spectrum analyzer, while maintaining mobile connections.

This port should always be terminated with 50  $\Omega$

---

**NOTE:**

---

The maximum input power to be applied to this port is 200 mW.

#### 6. Aux RF In and Aux RF Out Connections

These two connections are the same as those on the Standard HP/Agilent 8922 Test System. Refer to the *Agilent 83220A/E User's Guide* for more information.

---

**NOTE:**

---

Please use the supplied BNC cables for these connections. If your installation requires longer cable lengths, ensure they are of **double screened** construction.

#### 7. 1710-1990 MHz Aux RF In & Aux RF Out Ports

These ports are only found on the HP/Agilent 83220A and are not useable during multi-band operation.

### 8. RF In/Out Path Diagram

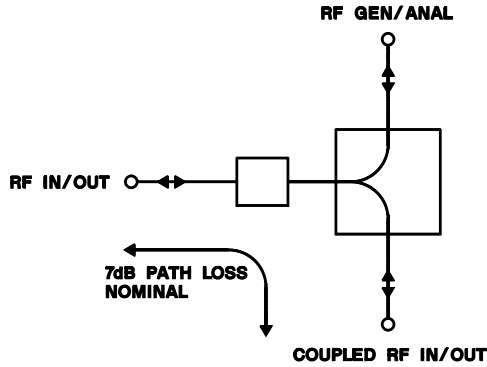

The diagram on the front panel of the HP/Agilent 83220 shows the signal path between the RF In/Out port, the coupled RF In/Out port and the HP/Agilent 8922.

### Rear Panel Connections

All rear panel connections between the HP/Agilent 8922 and HP/Agilent 83220 are the same as those of a Standard HP/Agilent 8922 Test System. Refer to the *Agilent 83220A/E User's Guide* for more information on rear panel connections.

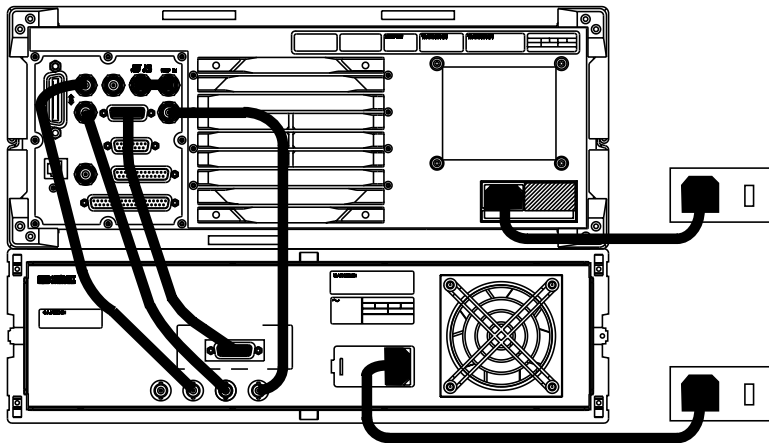

| HP/Agilent 83220A/E Connections | HP/Agilent 8922M/S Connections |
|---------------------------------|--------------------------------|
| AM                              | AM                             |
| SCOPE                           | SCOPE                          |
| 10 MHz IN                       | 10 MHz OUT                     |
| PCN INTERFACE                   | PCN INTERFACE                  |

---

## Calibration Routine

Once the HP/Agilent 8922 Multi-Band Test System has been connected, the system must be calibrated. The calibration routine can be used for both the HP/Agilent 83220A and the HP/Agilent 83220E.

---

**NOTE:**

---

The calibration routine must be run whenever one or more of the following situations arise:

- An HP/Agilent 83220 is first connected to an HP/Agilent 8922.
- When a different, or upgraded, HP/Agilent 83220 is connected to an HP/Agilent 8922.
- If different IF Link or Aux RF In/Out cables are used.
- After a RAM Initialize or Firmware Upgrade.
- Need to trouble shoot the system or localize faults.

### Procedure

- 1 Ensure you have the following parts<sup>1</sup>:
  - 6 dB coaxial attenuator (SMA)
  - BNC to SMA adapter
  - N-type to SMA adapter
  - BNC to BNC cable (minimum length 1.2m)
- 2 Ensure that the Coupled RF In/Out Port is terminated by 50  $\Omega$  (supplied with test system).
- 3 Switch on the HP/Agilent 8922 Multi-Band Test System.
- 4 Select **CONFIG** from the **To Screen**.
- 5 Select **Compatible** field and change to **8922E** or **8922G**, if required.
- 6 Power cycle the system.
- 7 Press the front panel **TESTS** key.
- 8 Set **Location** to **ROM**
- 9 Select **Procedure** field.
- 10 Select the test routine **SYS\_CAL**.
- 11 Run the program by either selecting the **Run Test** field or by pressing **L1**.

1. These are a list of parts included in the calibration kit - HP/Agilent 8922U Option 104.

- 12 Using the parts listed, follow the instructions given on the display.
- 13 Once this calibration process is completed, you are asked to power cycle the system. Before doing this, return the **Compatible** field back to the original state (Step 4 through to 6).

---

**WARNING:**

---

If **RAM Initialize** is carried out, the offset calibration values will be erased. This will result in unexpected and uncalibrated results.

Repeat the calibration process to restore the offset calibration values.

### Default Start Up Mode

Once the system has been connected and calibrated, it is possible to set up which radio mode the system will always start up with.

The start up radio mode is set using the service latch **default\_radio\_mode**. This latch can be set from the service screen. The following table lists the options for this service latch.

| Radio Mode | Latch Value |
|------------|-------------|
| GSM900     | 0           |
| E-GSM900   | 1           |
| DCS 1800   | 2           |
| PCS 1900   | 3           |

The HP/Agilent 8922 Multi-Band Test System will return to the **default\_radio\_mode** after;

- The system has been switched off and on.
- Press **PRESET**.
- Using GPIB code \*RST.

## Zero the Power Meter

The HP/Agilent 8922 and HP/Agilent 83220 each have independent power meters. When testing a mobile in the GSM900 (and E-GSM) band the HP/Agilent 8922 power meter is used to measure the transmitted power level from the mobile, and when testing a mobile in the DCS1800 band the HP/Agilent 83220 power meter is used. To ensure that both instruments' power meters function correctly, they must be zeroed before instrument operation and then regularly in subsequent operation to guarantee continued measurement accuracy.

**NOTE:**

Failure to regularly zero the HP/Agilent 8922 and HP/Agilent 83220 power meters results in measurement inaccuracies after a long period of time. Although both instruments are always zeroed prior to shipping from the factory, they still require their power meters to be regularly zeroed to guarantee measurement accuracy. It is recommended that the power meters are zeroed on a weekly basis as a minimum. Note that it is not a requirement to zero the power meter for every mobile that is tested.

### To Zero the Power Meter of the HP/Agilent 8922

- 1 Ensure that no external instruments, test devices or mobiles are connected to the HP/Agilent 8922 Multi-Band Test System.
- 2 Switch on the HP/Agilent 8922 Multi-Band Test System, navigate to the CONFIGURE screen, select the Radio Type and set it to GSM900 or E-GSM.
- 3 Press the front panel **CELL CNTL** to display the Cell Status screen and select the **Pwr Zero** field.

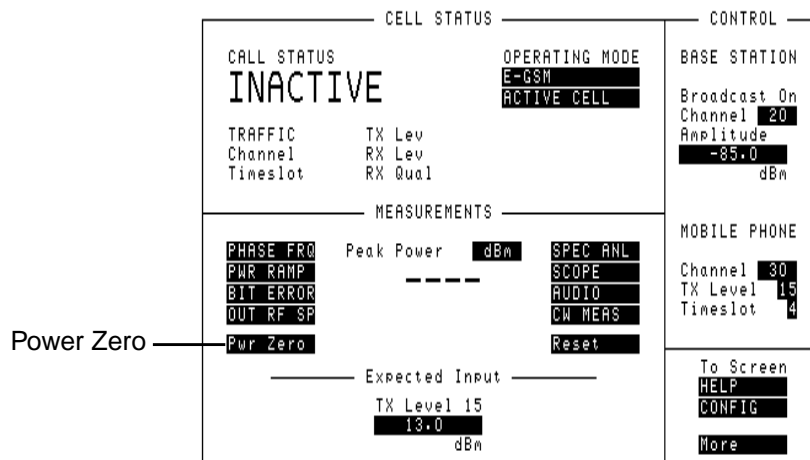

- Once selected, the power meter will automatically zero.

### To Zero the Power Meter of the HP/Agilent 83220

**NOTE:**

In Dual-Band test mode the Test Set is initially set to E-GSM and in this mode the power zero is applied only to the HP/Agilent 8922 Power Meter. Because of this, the HP/Agilent 83220 Power Meter must be zeroed separately by setting the Radio Type to DCS1800.

- Ensure that no external instruments, test devices or mobiles are connected to the HP/Agilent 8922 Multi-Band Test System.
- Switch on the HP/Agilent 8922 Multi-Band Test System, navigate to the CONFIGURE screen, select the Radio Type and set it to DCS1800 or PCS1900.
- Press the front panel **CELL CNTL** to display the Cell Status screen and select the **Pwr Zero** field.

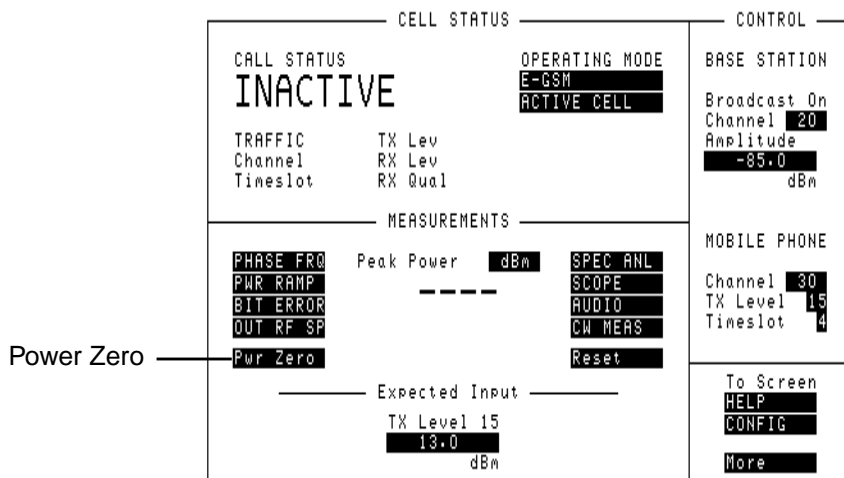



- Once selected, the power meter will automatically zero.

For details of recommended GPIB commands for including power zeroing in the initialization routine for testing of Dual-Band type mobiles, see “GPIB Commands for Including Power Zeroing in an Automatic Test Routine” on page 4-44.



## Checking the Current Status of the Power Meters

Use the following simple, manual method to check the current status of your Test Set using a Dual-Band mobile:

- 1 Press the front panel  to display the Cell Status screen and set the Operating Mode to E-GSM.
- 2 Connect the mobile to the Test Set RF In port, power it on and wait for it to camp-on to the Test Set BCH.
- 3 Establish a call and note the value of the Peak Power (Fast Power) measurement center screen.
- 4 End the call and power off the mobile.
- 5 Remove the connection to the front panel to ensure no RF power.
- 6 Press the front panel  to display the Cell Status screen and select the **Pwr Zero** field.
- 7 Repeat steps 2 and 3.
- 8 Compare the two Peak Power measurements. Any difference is most probably due to the Power Zero meter.
- 9 Repeat steps 1 through 8 for the Radio Type set to DCS1800 (that is, to check the HP/Agilent 83220 power meter).

Configuring the HP/Agilent 8922 Multi-Band Test System  
**Zero the Power Meter**

---

## How to Section

This section describes some of the basic procedures that may be required while operating the HP/Agilent 8922 Multi-Band Test System. For more details on operating procedures, refer to the *Agilent 8922MIS User's Guide*.

---

**NOTE:**

---

Before trying these procedures, you should be in E-GSM900 mode for multi-band operation.

---

## Power-up and Operating Mode Selection

This section describes the procedure for powering up the HP/Agilent 8922 Multi-Band Test System and then establishing a call with an attached mobile.

- 1 Power on HP/Agilent 8922 Multi-Band Test System and observe display.
- 2 The system start up cycle will be suspended and an error message will be displayed if the HP/Agilent 83220 is not connected, or is not operating properly. Check connections and instrument, then power cycle the system.
- 3 Select **E-GSM** radio mode from the cell status screen.

---

**NOTE:**

---

This step can be avoided if the default start up mode has already been set. Refer to *Default Start Up Mode* on page 8 for more information about setting this service latch.

- 4 Connect the mobile to RF IN/OUT port located on the front panel of the HP/Agilent 83220 (refer to 4. *GSM/DCS/PCS RF In/Out Port* on page 5 for more information about this port).
- 5 Switch on the mobile.
- 6 The mobile should then camp onto the E-GSM900 broadcast channel. This is indicated by the mobile displaying 001-01.

### Potential Problems

If a phase-1<sup>1</sup> mobile is being tested and E-GSM mode is selected the mobile will not be able to camp on. To check the type of mobile being used, power cycle the instrument and try to camp on while in GSM900 mode.

1. A mobile that is only compliant to phase 1 of the ETSI specifications.

---

## Establishing a Call

This procedure is identical to that of a Standard HP/Agilent 8922 Test System.

- 1 Once the mobile has been connected and camped on to the HP/Agilent 8922 Multi-Band Test System, key in any number on the mobile.
- 2 Now initiate the call from the mobile. The display on the HP/Agilent 8922 should now show that the call status is **CONNECTED**.

### Potential Problems

If a call is not established, the uplink power may differ from the HP/Agilent 8922's expected input level. The most likely reason for this type of problem is that the mobile or the IF Link cable has not been calibrated. Refer to *Calibration Routine* on page 7 for more details on calibrating the IF Link cable.

---

## **Making Measurements in the E-GSM900 Band**

The procedures for making measurements in the E-GSM900 band are the same as those used for a Standard HP/Agilent 8922 Test System. Refer to the *Agilent 8922M/S User's Guide* for more information.

---

## Changing Band

### Assignment

#### E-GSM900 to DCS1800

- 1 Select the Dual Band screen (Refer to *Dual Band Control Screen* on page 26 for more information).
- 2 Change the field to Assign, **Assign/Handover** .
- 3 Select **Channel**, **Tx Level** and **Input Level** for the initial DCS1800 operating parameters.
- 4 Select **Execute** - this will change the band.
- 5 An assignment command is sent to the mobile and the HP/Agilent 8922 is now operating with the TCH in DCS1800 mode. However, the broadcast channel will always stay in the E-GSM900 band.

#### DCS1800 to E-GSM900

- 1 Select the Dual Band screen (Refer to *Dual Band Control Screen* on page 26 for more information).
- 2 Change the field to Assign, **Assign/Handover** .
- 3 Select **Channel**, **Tx Level** and **Input Level** for the initial E-GSM900 operating parameters.
- 4 Select **Execute** - this will change the band.
- 5 An assignment command is sent to the mobile and the HP/Agilent 8922 is now operating with the TCH and broadcast channel in the E-GSM900 band.

## Handover

### E-GSM900 to DCS1800

- 1 Select Dual Band Screen (Refer to *Dual Band Control Screen* on page 26 for more information).
- 2 Change the field to Handover, **Assign/Handover** .
- 3 Select **Channel**, **Tx Level** and **Input Level** for the initial DCS1800 operating parameters.
- 4 Select **Execute** - this will change the band.
- 5 A handover command is sent to the mobile and the HP/Agilent 8922 is now operating with the TCH in DCS1800 band. However, the broadcast channel will always stay in the E-GSM900 band.

### DCS1800 to E-GSM900

- 1 Select Dual Band Screen (Refer to *Dual Band Control Screen* on page 26 for more information).
- 2 Change the field to Handover, **Assign/Handover** .
- 3 Select **Channel**, **Tx Level** and **Input Level** for the initial E-GSM900 operating parameters.
- 4 Select **Execute** - this will change the band.
- 5 A handover command is sent to the mobile and the HP/Agilent 8922 is now operating with the TCH and broadcast channel in the E-GSM900 band.



---

## Making Measurements in the DCS1800 Band

The procedures for making measurements in the DCS1800 Band are the same as those used for a Standard HP/Agilent 8922 Test System. Refer to the *Agilent 8922M/S User's Guide* for more information.

Measurements can not be made for hopped calls while using multi-band mode. If, however, a measurement needs to be made for a hopped call, use the following procedure.

- 1 End call
- 2 Return to the Cell Status screen
- 3 Select DCS1800 mode
- 4 Power cycle the mobile
- 5 Re-establish the call
- 6 Make the measurements

---

## **Ending A Call**

Ending a call is the same procedure as that used for a Standard HP/Agilent 8922 Test System. Refer to the *Agilent 8922MIS User's Guide* for more information.

When a call is ended for any reason, the current band will return to E-GSM900.

---

## **Screens**

The following section describes the screens that are part of the HP/Agilent 8922 Multi-Band Test System. For more details on all other screens, refer to the *Agilent 8922M/S User's Guide*.

These screens are only available for firmware revision C.01.00, and onwards.

## Cell Configuration Screen

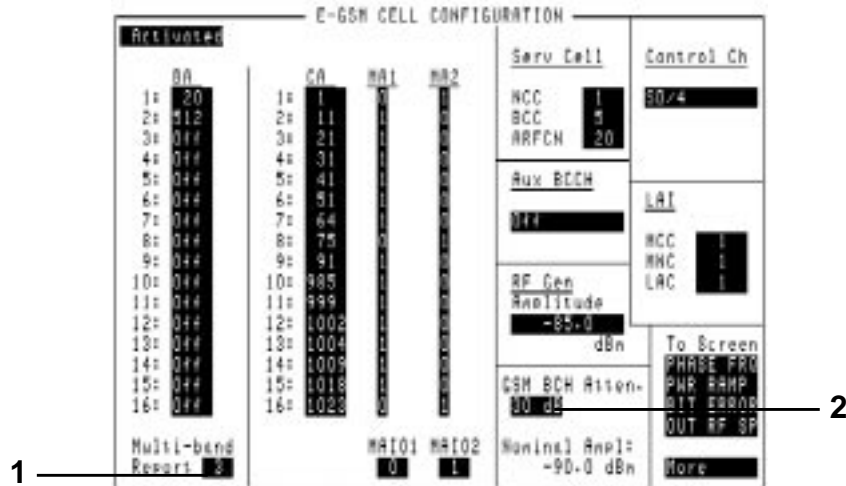

### 1. Multi-band Report

This field sets the number of neighbour cells, for each frequency band, which will be included in SACCH Adjacent Cell reports. The field value is encoded on the SACCH Channel.

|                |   |
|----------------|---|
| <b>Default</b> | 3   |
| <b>Range</b>   | 0 to 3  |
| <b>Choices</b> | 3 The mobile will report the top 3 adjacent cell measurements in each band.         |
|                | 2 The mobile will report the top 2 adjacent cell measurements in each band.         |
|                | 1 The mobile will report the top adjacent cell measurement in each band.            |
|                | 0 The mobile will report the top 6 adjacent cell measurements irrespective of band. |

### 2. GSM BCH Atten. and Nominal Ampl

These two fields are only shown when in dual band operation. Refer to '5. Downlink Amplitudes' on page 28 for more information about these fields.

## Cell Status Screen - Active Cell

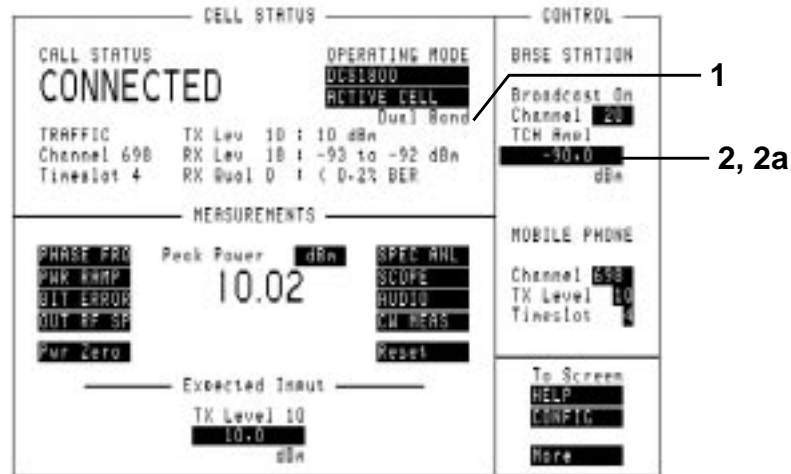

### 1. Dual Band

This field is displayed whenever the system is operating in dual band mode. When this field is displayed it is a reminder of the following;

- No hopped calls can be made
- The BCH is in the E-GSM900 band or TCH in is the DCS1800 band
- If the call is ended, for whatever reason, the operating mode will return to E-GSM900.

### 2. Amplitude

This field changes, depending on what operating mode the system is in. When in dual band mode with E-GSM900 band, this field shows the same setting as the **GSM BCH & TCH** field found on the **Downlink Amplitudes** section of the 'Dual Band Control Screen' on page 26.

### 2a. TCH Ampl

This field changes, depending on what operating mode the system is in. When in dual band mode with DCS1800 band, this field shows the same setting as the **DCS TCH** field found on the **Downlink Amplitudes** section of the 'Dual Band Control Screen' on page 26.

## Cell Status Screen - Test Mode



### 1. Dual Band, On/Off

This field appears when **TEST MODE** is selected, from the Cell Status screen.

| Choices | ON/OFF | When selected the BCH is in E-GSM900 band and the TCH in DCS1800 band. |
|---------|--------|--|
|         | ON/OFF | When selected the TCH and BCH are both in E-GSM900 band.               |

When the **Traffic Chan** is **ON/OFF**, turning the **Dual Band** field **ON/OFF** will cause the traffic channel to be generated in the DCS1800 band while the broadcast channel is in the E-GSM900 band.

The **Dual Band** field can only be set to **ON/OFF** when the operating mode is "E-GSM". The **Dual Band** field will automatically be turned off, if a change is made to either of the operating fields.

### 2. TCH Ampl OR Amplitude

This field changes depending on what the Dual Band field is set to. When **Dual Band** field is **ON/OFF** the field shows the DCS1800 TCH downlink amplitude. When the **Dual Band** field is **ON/OFF** the field shows the GSM BCH and TCH downlink amplitude.

## Configure Screen

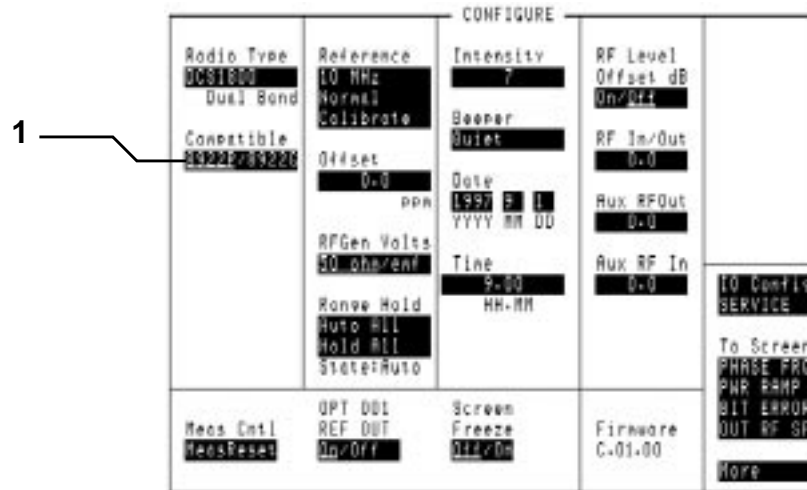

### 1. Compatible

This field selects the mode of operation of the HP/Agilent 8922. For more information about this field, refer to the *Agilent 8922M/S User's Guide*. The following table lists the various compatibility options against each HP/Agilent 8922 Multi-Band Test System.

| HP/Agilent 8922 Multi-Band Test System | HP/Agilent 83220 Option    | HP/Agilent 8922 Option | Compatible Options |
|--|----------------------------|------------------------|--------------------|
| HP/Agilent 8922P                       | HP/Agilent 83220E Opt. 010 | + HP 8922M Opt. 010    | <b>8922P/8922G</b> |
| HP/Agilent 8922R                       | HP/Agilent 83220E Opt. 010 | + HP 8922S Opt. 010    | <b>8922R/8922E</b> |
| HP/Agilent 8922X                       | HP/Agilent 83220A Opt. 010 | + HP 8922M Opt. 010    | <b>8922X/8922G</b> |
| HP/Agilent 8922Y                       | HP/Agilent 83220A Opt. 010 | + HP 8922S Opt. 010    | <b>8922Y/8922E</b> |

## Dual Band Control Screen

This screen is used for performing inter-band channel changes while dual band mobile testing. To access this screen;

- 1 Access the Cell Status screen.
- 2 Change the operating mode to **E-GSM**.
- 3 From the menu selection area, select **More**.
- 4 Scroll down the list of options and select **DUAL BAND**.

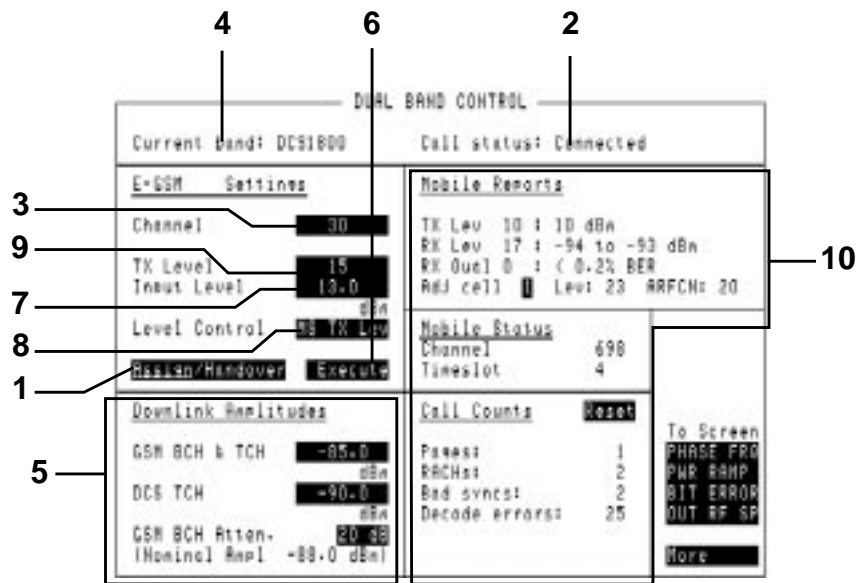

### 1. Assign/Handover

This field determines the method to be used for moving the traffic channel from one band to another. This field operates similarly to the TCH Control field found on the Cell Control 2 screen (refer to the *Agilent 8922MIS User's Guide* for details).

|               |                        |
|---------------|------------------------|
| Default Value | <b>Assign/Handover</b> |
|---------------|------------------------|



## 2. Call Status

This field displays the current status of the call. Refer to the Cell Status screen described in the *Agilent 8922M/S User's Guide* screens chapter.

## 3. Channel

This field is used when an inter-band channel change is requested. The mobile is told which channel to go to when **Execute** is selected. This field is similar to the ARFCN field on the Cell Control 2 screen (refer to the *Agilent 8922M/S User's Guide* for details).

|                 |         |                         |
|-----------------|---------|-------------------------|
| <b>E-GSM900</b> | Default | 30                      |
|                 | Range   | 0 to 124<br>975 to 1023 |
| <b>DCS1800</b>  | Default | 698                     |
|                 | Range   | 512 to 885              |

## 4. Current Band

This field shows the current traffic channel band and changes when an inter-band channel change is completed. Calls can only be established in the E-GSM900 band and if a call is ended for any reason this field defaults to this band.

|                      |              |
|----------------------|--------------|
| <b>Default Value</b> | <b>E-GSM</b> |
|----------------------|--------------|

## 5. Downlink Amplitudes

These 3 fields control the amplitudes of the downlink channels. These fields operate differently depending on which band is being used.

**E-GSM900 Band** When the traffic channel is in E-GSM900 band, the **GSM BCH & TCH** field will have an immediate effect. This field is identical to the RF Gen Amplitude field on the Cell Configuration screen.

The **GSM BCH Atten.** and **DCS TCH** fields have no effect until the traffic channel moves to the DCS1800 band.

|                          |         |  |
|--------------------------|---------|--|
| <b>GSM BCH &amp; TCH</b> | Default | -85 dBm  |
|                          | Range   | -6.0 dBm to -127.0 dBm (no electronic attenuation)   |
|                          |         | -7.0 dBm to -127.0 dBm (with electronic attenuation) |

**DCS1800 Band** When the traffic channel is in the DCS1800 band, the **GSM BCH & TCH** field has no effect until the traffic channel moves back to the E-GSM900 band.

The **GSM BCH Atten.** field controls the attenuation of the E-GSM900 BCH. The **DCS TCH** field controls the amplitude of the downlink traffic channel. Both these fields have an immediate effect.

|                       |         |                                  |
|-----------------------|---------|----------------------------------|
| <b>GSM BCH Atten.</b> | Default | 20 dB                            |
|                       | Range   | 0, 10, 20, 30, 40, 50, 60, 70 dB |
| <b>DCS TCH</b>        | Default | -85.0 dBm                        |
|                       | Range   | -127.0 dBm to -12.0 dBm          |

**GSM BCH Atten. and Nominal Ampl.** When the TCH is in the DCS1800 band, the BCH remains in the E-GSM900 band. The amplitude of this BCH is nominally -60 dBm. This level can be changed by introducing increasing levels of attenuation. For example, selecting **GSM BCH Atten.** **30 dB** will reduce the BCH amplitude to -90 dBm nominal.

---

**NOTE:** Although the absolute BCH level is a typical specification, the relative changes in amplitude are more accurate. To determine an accurate absolute level, refer to 'Appendix A - Establishing Absolute GSM BCH Power Level' on page 81 for more information.

---

## 6. Execute

This field starts the process of moving the traffic channel from one band to another. If no call is active, the inter-band channel change cannot be executed. If the inter-band channel change fails or the call drops for any other reason, the operating mode defaults to E-GSM900.

## 7. Input Level

This field sets the expected input level of the HP/Agilent 8922 RF Analyzer. The value set in this field will only be used once a inter-band channel change has been executed.

This field will be set by the **TX Level** field, if the **Level Control** field is set to **MS TX Lev**.

The **Level Control** field will change to **Manual** if the **Input Level** is changed.

When in compatibility mode (**8922E** or **8922G**) and **Level Control** field is set to **MS TX Lev**, then an error will occur if the **Input Level** is changed.

|                 |         |                       |
|-----------------|---------|-----------------------|
| <b>E-GSM900</b> | Default | 13 dBm                |
|                 | Range   | -27.9 dBm to 41.0 dBm |
| <b>DCS1800</b>  | Default | 10 dBm                |
|                 | Range   | -47.9 dBm to 33.0 dBm |

## 8. Level Control

This field couples the **TX Level** and **Input Level** fields.

This field will be set to **Manual** if the **Input Level** is altered.

|                |                  |  |
|----------------|------------------|--|
| <b>Choices</b> | <b>MS TX Lev</b> | Any changes to the <b>TX Level</b> field will also change the value of the <b>Input Level</b> field.   |
|                | <b>Manual</b>    | Any changes to the <b>TX Level</b> field will effect the <b>Input Level</b> field and the <b>Level Control</b> changes automatically to <b>MS TX Lev</b> |

## 9. TX Level

This field tells the mobile which power level to use once a handover is requested.

This field is linked to the **Input Level** field, if the **Level Control** field is set to **MS TX Lev**.

If the **Level Control** field is set to **Manual** and the **TX Level** changes, the **Level Control** will change to **MS TX Lev**.

When in compatibility mode (**8922E** or **8922G**) and **Level Control** field is set to **MS TX Lev**, then the **Input Level** will follow the **TX Level**.

When in compatibility mode (**8922E** or **8922G**) and **Level Control** field is set to **Manual**, then only the **TX Level** will change.

|                 |         |         |
|-----------------|---------|---------|
| <b>E-GSM900</b> | Default | 15      |
|                 | Range   | 1 to 19 |
| <b>DCS1800</b>  | Default | 10      |
|                 | Range   | 0 to 15 |

## 10. Mobile Reports, Mobile Status and Call Counts

These fields are the same as those found on the Cell Control 2 screen. Values of these fields will change appropriately as the mobile changes between E-GSM900 and DCS1800 operating modes.

---

## Error and Help Screens

### Error Screen

This screen will be displayed if you try to access the Dual Band Control screen without first setting the radio mode to **E-GSM**. Select any other screen or press the **PREV** key to clear.



### Help Screen

To access this screen select **More** at the **To Screen** menu. Scroll down the list of options and select **HELP**. Follow the instructions given. Or select **HELP** from the **To Screen** menu.

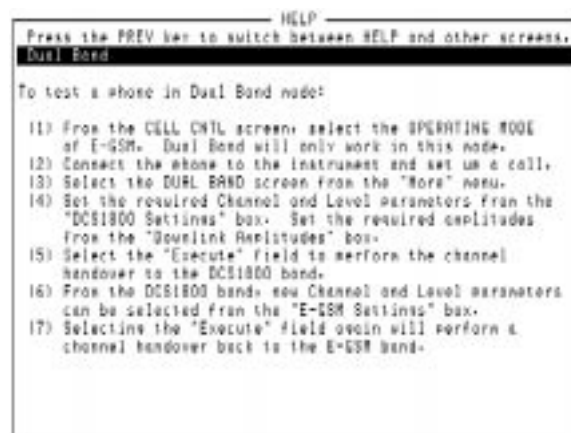

---

## MS Information/Signaling Screen

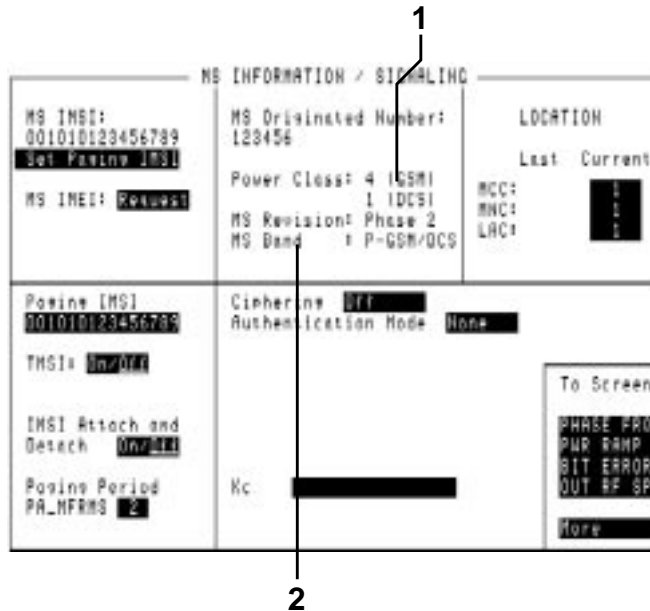

### 1. Power Class

This field displays the power class of the mobile. The display shows the power class for both bands.

When testing a single band mobile, this display will only show the power class for that band. Refer to the MS Information/Signalling screen in the *Agilent 8922MIS User's Guide* for more information.

### 2. MS Band

This field displays the bands supported by the mobile.

#### Display Options

- P-GSM/DCS
- E-GSM/DCS
- P-GSM
- E-GSM

---

## **GPIB Commands**

The following section details the additional GPIB commands that are part of the HP/Agilent 8922 Multi-Band Test System. For descriptions of syntax format and all other GPIB commands, refer to the *Agilent 8922M/S Programming Reference Guide*.

## Additional Commands to existing subsystems

### Cell Configuration Subsystem

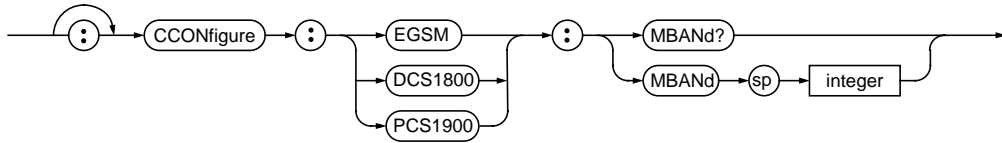

| Command Syntax                                      | Description  |
|---|--|
| CCONfigure:EGSM   DCS1800   PCS1900:MBANd?          | Queries the multiband reporting parameter                        |
| CCONfigure:EGSM   DCS1800   PCS1900:MBANd <integer> | <integer> = 0, 1, 2, 3<br>Sets the multiband reporting parameter |

### Display Subsystem

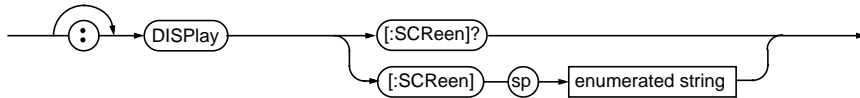

| Command Syntax         | Description   |
|------------------------|---|
| DISPlay[:SCReen] DBANd | Displays the Dual Band Control screen.<br>Refer to the <i>Agilent 8922M/S Programming Reference Guide</i> for a full listing of screen display options. |

### MS Information Subsystem

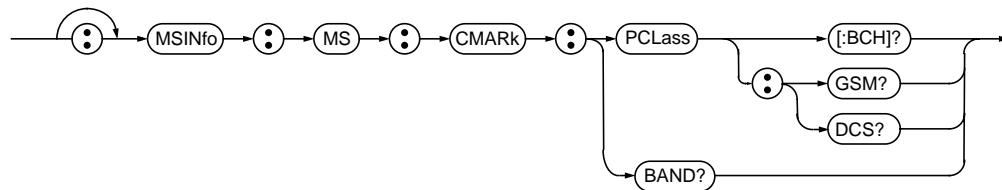



| Command Syntax                | Description   |
|-------------------------------|---|
| MSINfo:MS:CMARk:PCLass[:BCH]? | Queries the power class of the mobile when transmitting in the same band as the broadcast channel                     |
| MSINfo:MS:CMARk:PCLass:GSM?   | Queries the power class of the mobile when transmitting in the GSM900 band  |
| MSINfo:MS:CMARk:PCLass:DCS?   | Queries the power class of the mobile when transmitting in the DCS band   |
| MSINfo:MS:CMARk:BAND?         | Queries which bands are supported by the mobile<br>Return values;<br>"P-GSM/DCS"<br>"E-GSM/DCS"<br>"P-GSM"<br>"E-GSM" |

#### **Power Class Details**

The commands for querying the power class can have different results depending on which type of system is being operated. If the mobile is not multiband capable, using the queries **MSINfo:MS:CMARk:PCLASS:GSM?** and **MSINfo:MS:CMARk:PCLASS:DCS?** will return "-1".

---

## Dual Band Control Subsystem

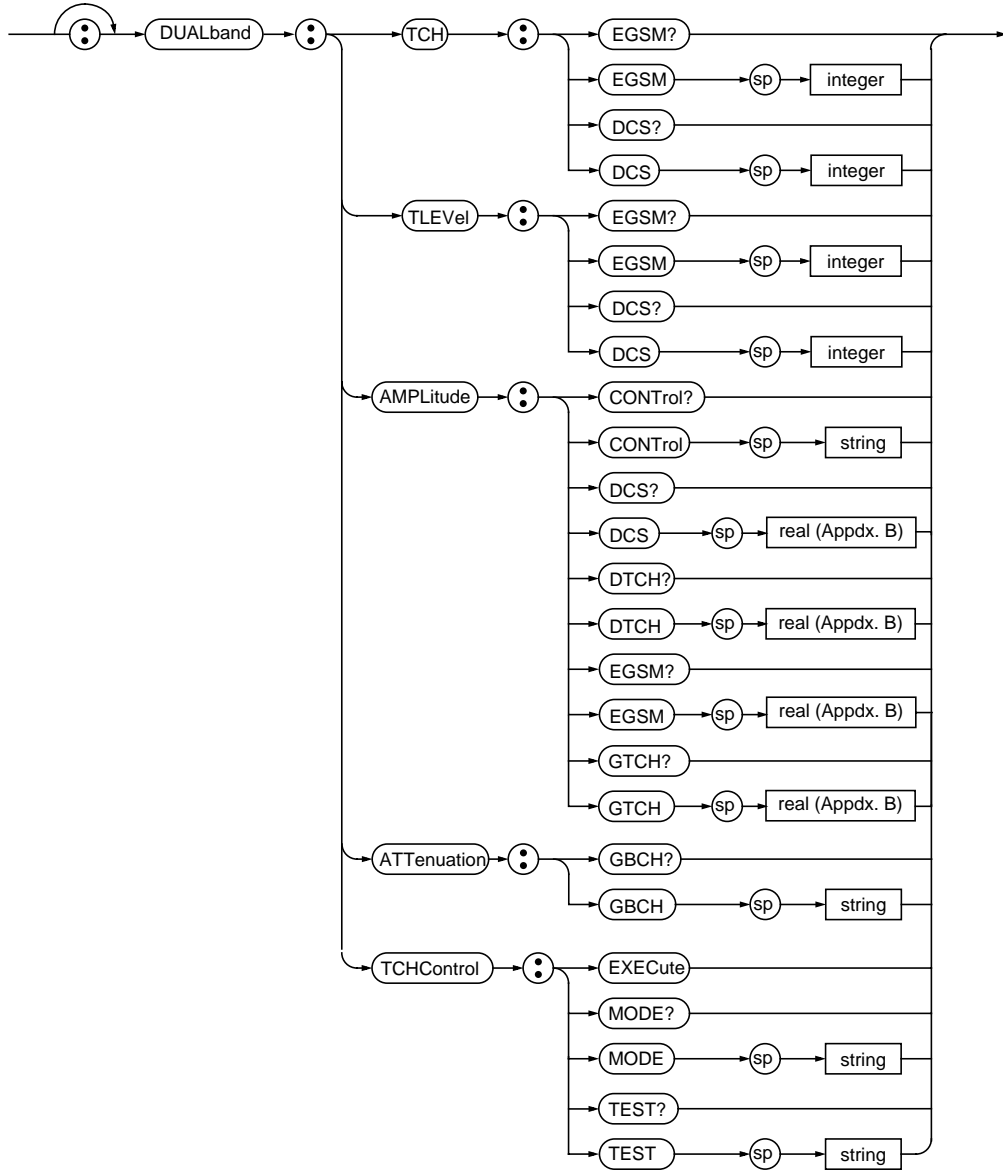

### E-GSM900 TCH Commands

These commands set the parameters that will be used for an E-GSM900 traffic channel after a handover or assignment is sent.

| Command Syntax                 | Description   |
|--------------------------------|---|
| DUALband:TCH:EGSM?             | Queries the E-GSM900 traffic channel ARFCN  |
| DUALband:TCH:EGSM <integer>    | Sets the E-GSM900 traffic channel ARFCN   |
| DUALband:TLEVel:EGSM?          | Queries the mobile Tx power level in E-GSM900 mode  |
| DUALband:TLEVel:EGSM <integer> | Sets the mobile Tx power level in E-GSM900 mode<br><integer> = 1 to 19  |
| DUALband:AMPLitude:EGSM?       | Queries the RF input level for E-GSM900   |
| DUALband:AMPLitude:EGSM <real> | Sets the RF input level for E-GSM900.<br>Refer to App B, <i>Agilent 8922M/S Programming Reference Guide</i>     |
| DUALband:AMPLitude:GTCH?       | Queries the GSM BCH + TCH downlink amplitude  |
| DUALband:AMPLitude:GTCH <real> | Sets the GSM BCH + TCH downlink amplitude<br>Refer to App B, <i>Agilent 8922M/S Programming Reference Guide</i> |

### DCS1800 TCH Commands

These commands set the parameters that will be used for a DCS1800 traffic channel after a handover or assignment is sent.

| Command Syntax                | Description   |
|-------------------------------|---|
| DUALband:TCH:DCS?             | Queries the DCS1800 traffic channel ARFCN   |
| DUALband:TCH:DCS <integer>    | Sets the DCS1800 traffic channel ARFCN<br><integer> = 512 to 885  |
| DUALband:TLEVel:DCS?          | Queries the mobile Tx power level in DCS1800 mode   |
| DUALband:TLEVel:DCS <integer> | Sets the mobile Tx power level in DCS1800 mode<br><integer> = 0 to 15                                     |
| DUALband:AMPLitude:DCS?       | Queries the RF input level for DCS1800  |
| DUALband:AMPLitude:DCS <real> | Sets the RF input level for DCS1800<br>Refer to App B, <i>Agilent 8922M/S Programming Reference Guide</i> |
| DUALband:AMPLitude:DTCH?      | Queries the DCS1800 TCH downlink amplitude  |

**GPiB Commands**  
**Dual Band Control Subsystem**

| Command Syntax  | Description  |
|---|--|
| DUALband:AMPLitude:DTCH <real>  | Sets the DCS1800 TCH downlink amplitude<br>Refer to App B, <i>Agilent 8922M/S Programming Reference Guide</i>        |
| DUALband:ATTenuation:GBCH?  | Queries the GSM BCH downlink attenuation   |
| DUALband:ATTenuation:GBCH '0 dB'<br>DUALband:ATTenuation:GBCH '10 dB'<br>DUALband:ATTenuation:GBCH '20 dB'<br>DUALband:ATTenuation:GBCH '30 dB'<br>DUALband:ATTenuation:GBCH '40 dB'<br>DUALband:ATTenuation:GBCH '50 dB'<br>DUALband:ATTenuation:GBCH '60 dB'<br>DUALband:ATTenuation:GBCH '70 dB' | Sets the GSM BCH downlink attenuation with the TCH in DCS1800 band<br>BCH Level at 0 dB attenuation: -60 dBm typical |

**Dual Band Control Commands**

| Command Syntax  | Description  |
|---|--|
| DUALband:AMPLitude:CONTRol?   | Queries the control for the RF analyzer input level  |
| DUALband:AMPLitude:CONTRol 'MANUAL'<br>DUALband:AMPLitude:CONTRol 'MS TX LEV' | Sets the control for the RF analyzer input level   |
| DUALband:TCHControl:EXECute   | Executes the traffic channel handover or assignment. This command uses the previously defined parameters for the new traffic channel   |
| DUALband:TCHControl:MODE?   | Queries the control for the TCH handover/assignment mode   |
| DUALband:TCHControl:MODE 'ASSIGN'<br>DUALband:TCHControl:MODE 'HANDOVER'      | Sets the control for the TCH handover/assignment mode  |
| DUALband:TCHControl:TEST?   | Queries the Dual Band mode status when in test mode  |
| DUALband:TCHControl:TEST 'ON'<br>DUALband:TCHControl:TEST 'OFF'               | Sets the Dual Band mode status when in test mode<br>When 'ON' - The BCH is in the E-GSM900 band and the TCH is in the DCS1800 band<br>When 'OFF' - The BCH and TCH are both in the E-GSM900 band |

---

## GPIB Programming Example Overview

The following example program performs a channel assignment, from the E-GSM900 band, to the DCS1800 band and back again.

### Program Overview

This example GPIB program is made up from the following programming blocks;

- Set up call parameters
- Set up GPIB parameters
- Prepare Test Set for a call
- Wait for Mobile to find service
- Set IMSI and page the Mobile
- Loop until call connected
- Check for paging time-out
- Display the Dual Band screen and set downlink amplitudes
- Set up DCS1800 band parameters
- Execute the assignment
- Wait for Mobile to report that if the traffic channel is on the DCS1800 ARFCN
- Check assignment did not timeout then continue
- Set call parameters for returning to E-GSM900
- Execute the assignment
- Check assignment did not timeout and continue

GPIB Commands  
Example

---

**Example**

```
10  !-----!
20  !
30  ! Example program to perform a channel assignment from the EGSM band !
40  ! to the DCS band and back again !
50  !
60  !
70  !
80  !-----!
90  !
100 !
110 ! Setup Call parameters
120 !
130 Dcs_arfcn=698 ! ARFCN to assign to in the DCS band
140 Gsm_arfcn=30 ! ARFCN to assign to in the EGSM band
150 Imsi$=""001012345678901"" ! IMSI used to page the Mobile
160 !
170 !
180 ! Setup GPIB parameters
190 !
200 Page_tout=20 ! Timeout when waiting for the call to connect. In seconds
210 Assign_tout=5 ! Timeout when waiting for the assignment to complete
220 Addr=714 ! GPIB address of the HP/Agilent 8922
230 !
240 !
250 !
260 ! Prepare the Test Set for a call. For Dual Band operation, the call
270 ! must be originated in the E-GSM band, using the E-GSM Radio Mode (which
280 ! should be used to test Phase 2 P-GSM).
290 !
300 DISP "Resetting 8922 Test Set"
310 OUTPUT Addr;"*RST"
320 WAIT 5
330 OUTPUT Addr;"CONF:RAD `E-GSM'"
340 OUTPUT Addr;"CONF:RAD?"
350 ENTER Addr;A$
360 IF A$<>"E-GSM" THEN
370     PRINT "Instrument did not change to E-GSM Radio Mode."
380     STOP
390 END IF
400 !
410 !
420 !
430 ! Wait for the Mobile to find Service
440 !
450 DISP "Switch mobile on, Press ""Continue"" when mobile finds service"
```

```

460 PAUSE
470 !
480 !
490 !
500 ! Setup the Mobile's IMSI and then page the mobile
510 !
520 OUTPUT Addr;"MSInfo:PAGing:IMSIidentity ";Imsi$
530 DISP "Paging Mobile..."
540 OUTPUT Addr;"CELL:CALL:ORIG"
550 !
560 !
570 !
580 ! Go around a loop until the call is connected
590 !
600 Times=0
610 REPEAT
620     WAIT .2
630     Times=Times+.2
640     OUTPUT Addr;"CELL:CALL:STATUS:STATE?"
650     ENTER Addr;Stat$
660     IF Stat$="" "ALERTING"" THEN
670         DISP "Mobile is ringing, answer call"
680     END IF
690 UNTIL ((Stat$="" "CONNECTED"" ) OR (Times>Page_tout))
700 !
710 !
720 !
730 ! Check to ensure the page timeout did not expire before continuing
740 !
750 IF Times>Page_tout THEN
760     PRINT "Mobile did not respond to page within ";Page_timeout;"seconds."
770     STOP
780 END IF
790 !
800 !
810 !
820 ! Display the Dual Band control screen and set up the Downlink Amplitudes
830 !
840 DISP "Prepare for inter-band assignment to DCS"
850 OUTPUT Addr;"DISP DBAND"
860 OUTPUT Addr;"DUAL:AMPL:GTCH -85DBM" ! Ampl of E-GSM BCH + TCH
870 OUTPUT Addr;"DUAL:AMPL:DTCH -80DBM" ! Ampl of DCS TCH
880 OUTPUT Addr;"DUAL:ATT:GBCH `30 dB'" ! Ampl of E-GSM BCH when TCH is DCS
890 !
900 !
910 !
920 ! First do an assignment to the DCS band. Setup the DCS band parameters
930 OUTPUT Addr;"DUAL:TCH:DCS ";Dcs_arfcn
940 OUTPUT Addr;"DUAL:TLEV:DCS 5"
950 OUTPUT Addr;"DUAL:TCHC:MODE `ASSIGN'"

```

## GPIB Commands Example

```
960  !
970  !
980  !
990  ! Now send the assignment command
1000 !
1010 DISP "Execute multi-band assignment to DCS band"
1020 OUTPUT Addr;"DUAL:TCHC:EXEC"
1030 !
1040 !
1050 !
1060 ! Wait for the Mobile to report that the TCH is on the DCS ARFCN before
1070 ! we know the assignment was successful
1080 !
1090 Try=0
1100 REPEAT
1110     WAIT .2
1120     Try=Try+.2
1130     OUTPUT Addr;"CELL:CALL:STAT:TCH:ARFCN?"
1140     ENTER Addr;Arfcn
1150 UNTIL ((Arfcn=Dcs_arfcn) OR (Try>Assign_tout))
1160 !
1170 !
1180 !
1190 ! Check to ensure the assignment timeout did not expire before continuing
1200 !
1210 IF Try>Assign_tout THEN
1220     PRINT "Mobile did not assign to DCS TCH within ";Assign_tout;"seconds."
1230     STOP
1240 END IF
1250 DISP "Multi-band assignment to DCS successful"
1260 !
1270 !
1280 !
1290 ! The assignment to the DCS TCH was successful.
1300 ! At this point we could perform measurements on the DCS TCH
1310 !
1320 WAIT 5
1330 !
1340 !
1350 !
1360 ! Now we set up the parameters for returning to the GSM band
1370 !
1380 DISP "Prepare for assignment to E-GSM"
1390 OUTPUT Addr;"DUAL:TCH:EGSM ";Gsm_arfcn
1400 OUTPUT Addr;"DUAL:TLEV:EGSM 10"
1410 !
1420 !
1430 !
1440 ! Now send the assignment command
1450 !
```



```
1460 DISP "Execute multi-band assignment to GSM band"
1470 OUTPUT Addr;"DUAL:TCHC:EXEC"
1480 Try=0
1490 REPEAT
1500     WAIT .2
1510     Try=Try+.2
1520     OUTPUT Addr;"CELL:CALL:STAT:TCH:ARFCN?"
1530     ENTER Addr;Arfcn
1540 UNTIL ((Arfcn=Gsm_arfcn) OR (Try>Assign_tout))
1550 !
1560 !
1570 !
1580 ! Check to ensure the assignment timeout did not expire before continuing
1590 !
1600 IF Try>Assign_tout THEN
1610     PRINT "Mobile did not assign to GSM TCH within ";Assign_tout;"seconds."
1620     STOP
1630 END IF
1640 DISP "Multi-band assignment to GSM successful"
1650 !
1660 !
1670 !
1680 !
1690 STOP
1700 END
```

---

## **GPIB Commands for Including Power Zeroing in an Automatic Test Routine**

The following GPIB commands are recommended for inclusion in the initialization routine for testing Dual-Band type mobiles. For details on zeroing the HP/Agilent 8922 and HP/Agilent 83220 power meters manually, see “Zero the Power Meter” on page 1-9.

```
OUTPUT 714; "CONF:RADIO `DCS1800`"
```

```
OUTPUT 714; "CW:PMZ"
```

```
OUTPUT 714; "CONF:RADIO `E-GSM`"
```

```
OUTPUT 714; "CW:PMZ"
```

Zeroing power in the above order ensures that the Test Set is returned to E-GSM Radio Type in preparation for testing of a Dual-Band mobile.

Note that the command **"CW:PMZ"** is equivalent to **"DSP:AMPL:PMZ"**.

---

## **System Specifications**

These specifications describe the system's warranted performance and apply after a 30 minute warm-up. These specifications are valid over its operating and environmental range, unless otherwise stated.

---

## **Supplemental Characteristics (*shown in italics*)**

These are intended to provide additional information, useful in applying the instrument by giving typical (expected), but not warranted performance parameters. These characteristics are shown in *italics* or labeled as ‘typical’, ‘usable to’ or ‘nominal’.

---

**NOTE:**

The following specifications are only applicable to firmware revision C.01.00 onwards.

---

## GSM Functionality Specifications

|  |   |
|--|---|
| <b>Bit/frame error rate measurements:</b>      | Class Ia, Ib, and Class II bits in both raw and residual form, Burst-by-Burst   |
| <b>MS power output level control:</b>          | 1 to 19 for E-GSM900<br>1 to 15 for GSM900<br>0 to 15 for DCS1800<br>0 to 15, 30, 31 for PCS1900  |
| <b>Broadcast channel capability:</b>           | BCCH + CCCH or<br>BCCH + CCCH + SDCCH/4   |
| <b>Control channels (SDCCH, FACCH, SACCH):</b> | BCCH + CCCH, BCCH + CCCH + SDCCH/4, SDCCH/8 (non-hopped), SACCH/FACCH   |
| <b>Call control capabilities:</b>              | BS originated call (FS), MS originated call (FS), MS camp-on, BS call disconnect, MS call disconnect, Handover, Channel Assignment, Inter-band handover <sup>1</sup> and inter-band channel assignment <sup>1</sup> |
| <b>Traffic channels:</b>                       | TCH/FS  |
| <b>Timing:</b>                                 | Auto, manual, uplink-downlink and offset measurement  |
| <b>Hopping:</b>                                | Two independent, user definable MA tables with offsets. Intra band only   |
| <b>Speech encoding/decoding:</b>               | Full rate speech  |
| <b>Speech echo mode:</b>                       | User selectable delay 0 to 5.1 seconds  |
| <b>Measurement coordination:</b>               | Flexible control of burst type, ARFCN and timeslot  |
| <b>SACCH MEAS result - serving cell:</b>       | RXLEV, RXQUAL and timing advance  |
| <b>SACCH MEAS result - neighbour cell:</b>     | RXLEV, ARFCN, BCC, NCC  |

1. Dual band operation only.

---

## RF Generator Specifications

### RF In/Output connector Frequency

|                    |                                     |
|--------------------|-------------------------------------|
| <b>Range:</b>      | 880 to 960 MHz and 1805 to 1990 MHz |
| <b>Resolution:</b> | 1 Hz                                |
| <b>Accuracy:</b>   | Reference accuracy $\pm 0.5$ Hz     |
| <b>Stability:</b>  | Same as reference                   |

### RF In/Output Connector Output

|   |  |
|---|--|
| <b>Level Range for specified accuracy:</b>          | -14 to -127 dBm (880 to 960 MHz)<br>-19 to -127 dBm (1805 to 1990 MHz)   |
| <b>Typical maximum output power:</b>                | > -12 dBm (880 to 960 MHz)<br>> -19 dBm (1805 to 1990 MHz)   |
| <b>Level resolution:</b>                            | 0.1 dB   |
| <b>Level accuracy (880 to 960 MHz)<sup>1</sup>:</b> | $\pm 1.1$ dB (0°C to 10°C)<br>$\pm 1.0$ dB (10°C to 35°C)<br>$\pm 1.05$ dB (35°C to 45°C)<br>$\pm 1.1$ dB (45°C to 55°C)     |
| <b>Level accuracy (1805 to 1880 MHz):</b>           | 1 dB<br>$\pm 1$ dB typical (1880 to 1990 MHz)<br>$\pm 1$ dB typical while hopping  |
| <b>Reverse power:</b>                               | 15W peak, 8W average (880 to 960 MHz while in GSM900 and E-GSM900 mode)<br>2W continuous for all other frequencies and modes |
| <b>Typical SWR:</b>                                 | 1.5:1  |

1. Level accuracy degrades 0.2 dB when using RF In/Out connector for both RF generator and RF analyzer.

**Supplemental characteristics in E-GSM900 mode when BCH is in GSM900 band and TCH is in DCS1800 band**

|  |  |
|--|--|
| <b><i>BCH level at 0 dB attenuation:</i></b>   | <i>-60 dBm typical</i>   |
| <b><i>Attenuator resolution:</i></b>           | <i>10 dB steps</i>   |
| <b><i>Attenuator range:</i></b>                | <i>0 to 70 dB</i>  |
| <b><i>Attenuator accuracy:</i></b>             | <i>± 1.7% of setting or ± 0.4 dB, whichever is greater.</i>                  |
| <b><i>Level resolution for GSM900 BCH:</i></b> | <i>0.1 dB (when TCH in GSM900 band)<br/>10 dB (when TCH in DCS1800 band)</i> |
| <b><i>Level accuracy:</i></b>                  | <i>TCH: ± 1 dB typical<br/>BCH: ± 1 dB typical (when TCH in GSM900 band)</i> |

---

## 10 MHz to 1 GHz Aux RF Out Connector Specifications

### Frequency

|                    |                                 |
|--------------------|---------------------------------|
| <b>Range:</b>      | 10 MHz to 1 GHz                 |
| <b>Resolution:</b> | 1 Hz                            |
| <b>Accuracy:</b>   | Reference accuracy $\pm 0.5$ Hz |
| <b>Stability:</b>  | Same as reference               |

### Output

|  |  |
|--|--|
| <b>Level Range for specified accuracy:</b> | +4 to -127 dBm   |
| <b>Level resolution:</b>                   | 0.1 dB   |
| <b>Level accuracy<sup>1</sup>:</b>         | $\pm 1$ dB (880 to 960 MHz)<br>$\pm 1$ dB typical (50 MHz to 1 GHz)<br>$\pm 2$ dB typical (10 MHz to 50 MHz) |
| <b>Reverse power:</b>                      | 200 mW   |
| <b>SWR:</b>                                | 2.0:1 for level $< -4$ dBm   |

1. Level accuracy degrades 0.2 dB when using RF In/Out connector for both RF generator and RF analyzer.



---

## 1710 to 1990 MHz Aux RF Out Connector Specifications (HP/Agilent 83220A only)<sup>1</sup>

**Frequency**

|                    |                                 |
|--------------------|---------------------------------|
| <b>Range:</b>      | 1710 MHz to 1990 MHz            |
| <b>Resolution:</b> | 1 Hz                            |
| <b>Accuracy:</b>   | Reference accuracy $\pm 0.5$ Hz |
| <b>Stability:</b>  | Same as reference               |

**Output**

|  |  |
|--|--|
| <b>Level Range for specified accuracy:</b> | +7 to -127 dBm   |
| <b>Level resolution:</b>                   | 0.1 dB   |
| <b>Level accuracy:</b>                     | $\pm 1$ dB (1710 to 1880 MHz)<br><i><math>\pm 1</math> dB typical (1880 to 1990 MHz)</i> |
| <b>Reverse power:</b>                      | 200 mW   |
| <b>SWR:</b>                                | 2.0:1 for level $< -4$ dBm   |

**Spectral purity**

|                          |   |
|--------------------------|---|
| <b>Spurious signals:</b> | (for $\leq +1$ dBm output level at Aux RF out, or $\leq -19$ dBm output level at RF in/out) |
| <b>Harmonics:</b>        | $< -25$ dBc   |
| <b>Non-harmonics:</b>    | $< -50$ dBc, $> 5$ kHz offset from carrier  |

1. HP/Agilent 8922X and HP/Agilent 8922Y systems only

---

## 0.3 GMSK Modulation Specifications

After one timeslot, 577  $\mu$ s, from an isolated RF generator trigger in the GSM frequency bands.

### Error

|  |   |
|--|---|
| <b>Phase error:</b>                                | $\leq 1^\circ$ rms  |
| <b>Peak phase error:</b>                           | $\leq 4^\circ$ peak   |
| <b>Frequency error (880 to 960 MHz):</b>           | $\pm [0.02 \text{ ppm (18 Hz) + reference accuracy}]$ , for normal bursts<br><i>Typically <math>\pm [0.03 \text{ ppm (27 Hz) + reference accuracy}]</math>, for RACHs</i> |
| <b>Frequency error (1880 to 1990 MHz):</b>         | $\pm [0.01 \text{ ppm (22 Hz) + reference accuracy}]$ , for normal bursts<br><i>Typically <math>\pm [0.02 \text{ ppm (32 Hz) + reference accuracy}]</math>, for RACHs</i> |
| <b>Amplitude flatness:</b>                         | $\pm 0.25$ dB peak  |
| <b>Clock input Frequency (Agilent 8922M only):</b> | 270.833 kHz $\pm$ 2 Hz (relative to reference)  |
| <b>Level:</b>                                      | TTL   |
| <b>Data Input Format (Agilent 8922M only):</b>     | Non differentially encoded input  |
| <b>Level:</b>                                      | TTL   |

### *Supplemental characteristics*

*After three timeslots, 1.73 ms, from an isolated RF generator trigger in the GSM frequency bands<sup>1</sup>.*

|   |  |
|---|--|
| <b><i>Phase error:</i></b>                        | $\leq 0.5^\circ$ rms   |
| <b><i>Peak phase error:</i></b>                   | $\leq 2.0^\circ$ peak  |
| <b><i>Frequency error (880 to 960 MHz):</i></b>   | $\pm [0.01 \text{ ppm (9 Hz) + reference accuracy}]$<br><i>for normal bursts</i><br><i>Typically <math>\pm [0.02 \text{ ppm (18 Hz) + reference accuracy}]</math> for RACH bursts</i>  |
| <b><i>Frequency error (1880 to 1990 MHz):</i></b> | $\pm [0.005 \text{ ppm (9 Hz) + reference accuracy}]$<br><i>for normal bursts</i><br><i>Typically <math>\pm [0.01 \text{ ppm (18 Hz) + reference accuracy}]</math> for RACH bursts</i> |

1. GSM frequency bands are 880 to 915 MHz and 925 to 960 MHz.

---

## Pulse Modulation Specifications

**Input levels (Agilent 8922M Only):** TTL  
**Rise/fall time (10% to 90%):**  $\leq 5 \mu\text{s}$

*Supplemental characteristics*

*On/off ratio:*  $> 80 \text{ dB}$

---

## **30 dB Pulse Modulation Specifications (Agilent 8922M Only)**

All timeslots 30 dB higher than desired/active timeslot, to test adjacent timeslot rejection.

|                                     |                      |
|-------------------------------------|----------------------|
| <b>Input levels:</b>                | TTL                  |
| <b>Rise/fall time (10% to 90%):</b> | $\leq 5 \mu\text{s}$ |

---

## RF Analyzer Specifications

### RF in/out connector

**Frequency Range:** 880 to 960 MHz and 1710 to 1990 MHz

**Frequency Resolution:** 1 Hz

**Hop Mode Resolution:** 100 kHz

**Input Level range:** -5 to +41 dBm (880 to 960 MHz)

-5 to +32 dBm (1710 to 1990 MHz)

**Typical SWR:** 1.5:1

### 10 MHz to 1 GHz Aux RF In connector (HP/Agilent 8922 connector)

**Frequency Range:** 10 MHz to 1 GHz

**Frequency Resolution:** 1 Hz

**Hop Mode Resolution:** 100 kHz

**Input Level range:** -36 to +20 dBm

### 1710 to 1990 MHz Aux RF In connector (HP/Agilent 83220A only)<sup>1</sup>

**Frequency Range:** 1710 to 1990 MHz

**Frequency Resolution:** 1 Hz

**Hop Mode Resolution:** 100 kHz

**Input Level range:** -23 to +20 dBm

1. HP/Agilent 8922X, HP/Agilent 8922Y systems

---

## **CW RF Frequency Measurement Specifications**

|   |                                   |
|---|-----------------------------------|
| <b>Input frequency setting error:</b>     | $\pm 500$ kHz                     |
| <b>Accuracy:</b>                          | $\pm (1$ Hz + reference accuracy) |
| <b><i>Typical minimum resolution:</i></b> | <i>1 Hz</i>                       |

---

## CW RF Power Measurement Specifications (RF in/out) only

|  |   |
|--|---|
| <b>Input frequency setting range:</b>                          | $\pm 500$ kHz                               |
| <b>Accuracy</b><br><b>(880 to 960 MHz and +4 to +41 dBm):</b>  | $\pm 0.6$ dB $\pm$ noise effects (0.2 mW)   |
| <b>Accuracy</b><br><b>(1710 to 1880 MHz and 0 to +32 dBm):</b> | $\pm 0.5$ dB $\pm$ noise effects (0.015 mW) |

### *Supplemental Characteristics*

|   |   |
|---|---|
| <b>Accuracy</b><br><b>(880 to 960 MHz and -5 to +4 dBm):</b>  | $\pm 0.5$ dB $\pm$ noise effects (0.2 mW)   |
| <b>Accuracy</b><br><b>(1710 to 1880 MHz and -5 to 0 dBm):</b> | $\pm 0.5$ dB $\pm$ noise effects (0.015 mW) |
| <b>Accuracy (1880 to 1990 MHz):</b>                           | $\pm 0.5$ dB $\pm$ noise effects (0.015 mW) |
| <b>Minimum resolution (&gt;+4 dBm):</b>                       | 0.01 dB                                     |

## Peak Transmitter Carrier Power Measurement Specifications (RF in/out) only

**Input frequency setting range:**  $\pm 10$  kHz  
**Input level setting error:**  $\pm 3$  dB  
**Accuracy (880 to 960 MHz and +4 to +41 dBm):**  $\pm 0.7$  dB  $\pm$  noise effects (0.2 mW)  
**Accuracy (1710 to 1880 MHz and 0 to +32 dBm):**  $\pm 0.6$  dB  $\pm$  noise effects (0.015 mW)

### Supplemental Characteristics

**Accuracy (880 to 960 MHz and -5 to +4 dBm):**  $\pm 0.6$  dB  $\pm$  noise effects (0.2 mW)  
**Accuracy (1710 to 1880 MHz and -5 to 0 dBm):**  $\pm 0.6$  dB  $\pm$  noise effects (0.015 mW)  
**Accuracy (1880 to 1990 MHz):**  $\pm 0.6$  dB  $\pm$  noise effects (0.015 mW)  
**Minimum resolution (>+4 dBm):** 0.2 dB

Refer to the following 4 graphs for *typical* power measurement accuracies.

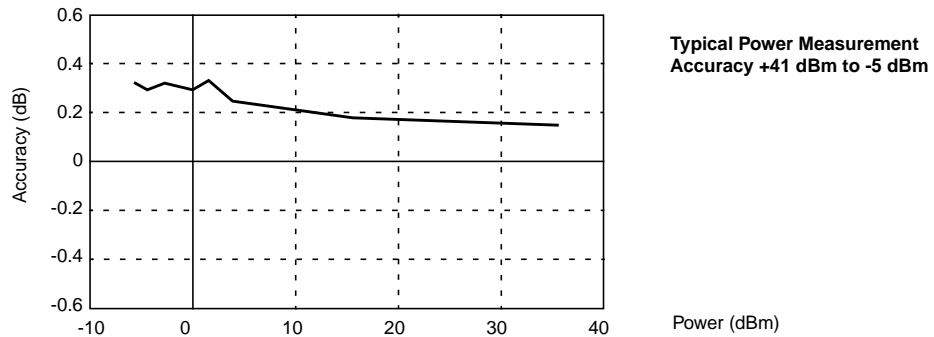
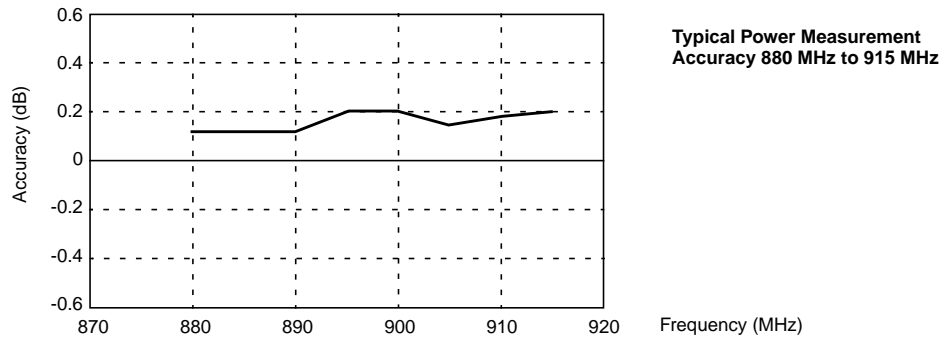



Peak Transmitter Carrier Power Measurement Specifications (RF in/out) only

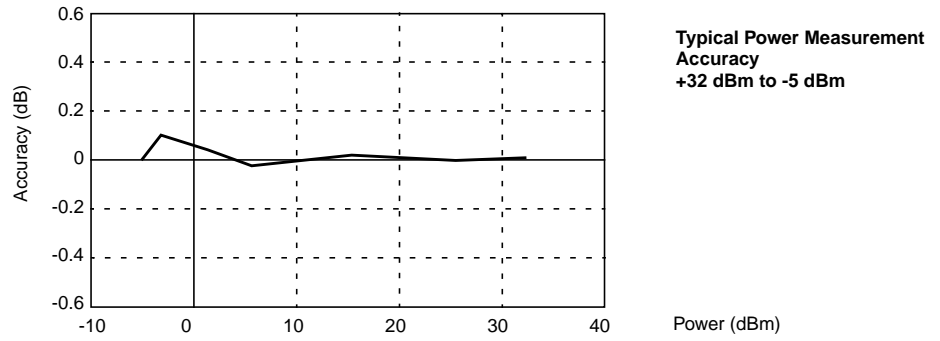
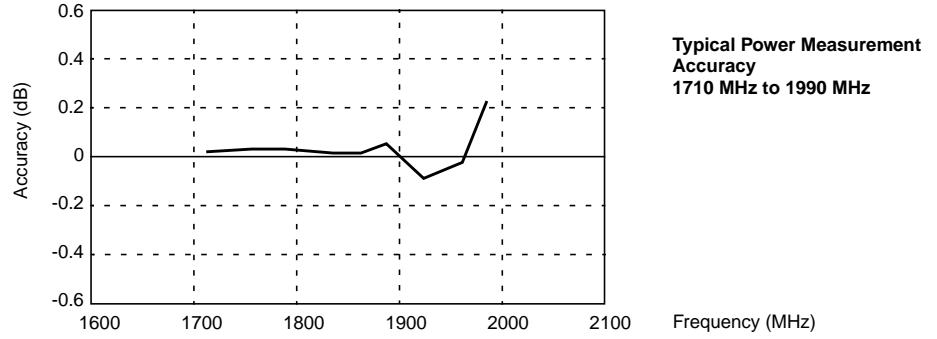

---

## Pulse on/off Ratio Measurement Specifications (requires option 006)

'On' power is averaged over the useful part of the burst. 'Off' is averaged over a one bit interval centered at a user specified time.

Non-hopped mode only

**Input frequency setting range:**  $\pm 10$  kHz  
**Input level setting range:**  $\pm 3$  dB  
**Timing accuracy:**  $\pm 1.7$   $\mu$ s ( $\pm 1.1$   $\mu$ s typical)

### Accuracy (on/off $\geq 40$ dB, RF in/out only)

| Off power<br>(dBm) | On/off ration accuracy |                        |
|--------------------|------------------------|------------------------|
|                    | -30 to -1              | $\pm 2.4$ dB           |
| -37 to -30         | $\pm 2.9$ dB           | $\pm 1.3$ dB typically |
| -41 to -37         | $\pm 3.7$ dB           | $\pm 1.7$ dB typically |
| -47 to -42         | $\pm 4.2$ dB           | $\pm 2.1$ dB typically |

---

## Amplitude Envelope Measurement Specifications

After one timeslot, 577  $\mu$ s from an isolated receiver hop trigger in the GSM frequency bands.

**Input frequency setting range**  $\pm 10$  kHz

### Inaccuracy due to noise (for overshoots 1 dB)

| Relative level | Input level setting error |                       |                            |
|----------------|---------------------------|-----------------------|----------------------------|
|                | $\pm 1$ dB                | $\pm 3$ dB            | $\pm 3$ dB with 5 averages |
| 0 dB           | < $\pm 0.15$ dB peak      | < $\pm 0.2$ dB peak   | < $\pm 0.2$ dB peak        |
| -6 dB          | < $\pm 0.2$ dB            | < $\pm 0.3$ dB        | < $\pm 0.3$ dB             |
| -30 dB         | < + 3.0 dB<br>-3.8 dB     | < + 4.2 dB<br>-7.5 dB | < + 2.2 dB<br>-2.6 dB      |

---

## Phase and Frequency Measurement Specifications

After one timeslot, 577  $\mu$ s from an isolated hop trigger in the GSM/DCS/PCS frequency bands.

**Input frequency setting range:**  $\pm 10$  kHz  
**Input level setting range:**  $\pm 3$  dB  
**RMS phase error accuracy:**  $\leq 1^{\circ}$  rms

### RMS phase error measurement versus measured value

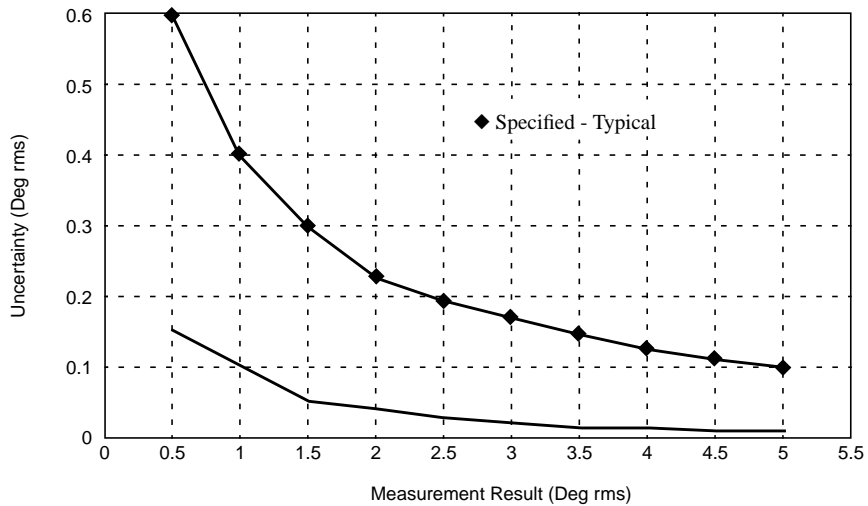

**Peak phase error accuracy:**  $\leq 4^{\circ}$  peak  
**Frequency error accuracy:**  $\pm (22 \text{ Hz} + \text{reference accuracy})$ , for normal bursts

### *Supplemental Characteristics*

**Frequency error accuracy:**  $\pm (9 \text{ Hz} + \text{reference accuracy})$  for normal bursts  
 $\pm (18 \text{ Hz} + \text{reference accuracy})$  for RACHs

---

## 0.3 GMSK Data Recovery Specifications (Agilent 8922M only)<sup>1</sup>

After one timeslot, 577  $\mu$ s, from an isolated receiver hop trigger in the GSM frequency bands.

|                                       |  |
|---------------------------------------|--|
| <b>Input frequency setting error:</b> | $\pm 100$ Hz                             |
| <b>Required input phase accuracy:</b> | $\leq 5^\circ$ rms, $\leq 20^\circ$ peak |
| <b>Demodulation duty cycle:</b>       | 1 timeslot per frame                     |
| <b>Outputs:</b>                       | Data, clock and data valid               |
| <b>Data output clock:</b>             | Clocked at 1 MHz rate                    |
| <b>Delay, data:</b>                   | $\leq 1$ frame (4.62 ms)                 |
| <b>Output level:</b>                  | TTL                                      |

1. HP/Agilent 8922P, HP/Agilent 8922X systems

---

## FM Demodulation Output Specifications (Agilent 8922M only)<sup>1</sup>

|                                       |   |
|---------------------------------------|---|
| <b>Sensitivity:</b>                   | 20 $\mu\text{V}/\text{Hz} \pm 5\%$ (into an open circuit) |
| <b>Input frequency setting range:</b> | $\pm 50$ kHz, with $\leq 100$ kHz peak deviation          |
| <b>Input level setting range:</b>     | $\pm 3$ dB  |

### *Supplemental characteristics*

|                          |               |
|--------------------------|---------------|
| <b>3 dB bandwidth:</b>   | DC to 270 kHz |
| <b>Output impedance:</b> | 600 ohm       |
| <b>DC offset:</b>        | $\leq 5$ mV   |

1. HP/Agilent 8922P, HP/Agilent 8922X systems

---

## Pulse Demodulation Output Specifications (Agilent 8922M only)<sup>1</sup>

|                                       |                    |
|---------------------------------------|--------------------|
| <b>Input frequency setting range:</b> | $\pm 50$ kHz       |
| <b>Input level setting range:</b>     | $\pm 3$ dB         |
| <b>Rise time (10 to 90%):</b>         | $\leq 2.5$ $\mu$ s |
| <b>Fall time (90 to 10%):</b>         | $\leq 2.5$ $\mu$ s |

### *Supplemental characteristics*

|                          |                                   |
|--------------------------|-----------------------------------|
| <b>Output impedance:</b> | 600 ohm, dc coupled               |
| <b>Output level:</b>     | 2 $V_{peak}$ into an open circuit |

1. HP/Agilent 8922P, HP/Agilent 8922X systems

---

## Output RF Spectrum Measurement Specifications (requires option 006)

After one timeslot, 577  $\mu$ s, from an isolated receiver hop trigger in the GSM frequency bands.

### Input Levels for optimum dynamic range (RF In/Out connector):

+7, +17, +27, +37 dBm (from 880 to 960 MHz)

-3, +2, +7, +12, +17, +22, +27, +32 dBm (from 1710 to 1990 MHz)

### Input frequency setting range:

$\pm 10$  kHz

### Input level setting range:

$\pm 3$  dB

### Supplemental characteristics

#### Log linearity:

$\pm 0.4$  dB

#### Amplitude flatness:

$\pm 1.0$  dB

#### Amplitude resolution:

0.4 dB

#### Dynamic range (dB):

*This describes the spectrum analyzer resolution bandwidth filter used when measuring output RF spectrum. The dynamic range of the measurement will be a combination of this filter response and the modulation spectrum of the incoming signal.*

|            | Offset (kHz) |     |     |     |     |             |
|------------|--------------|-----|-----|-----|-----|-------------|
|            | 100          | 200 | 300 | 400 | 600 | 800 to 1800 |
| Range (dB) | 24           | 42  | 53  | 60  | 63  | 64          |

*When using output RF spectrum due to the ramping measurement, the dynamic range is decreased by 12 dB (due to peak hold).*



## Spectrum Analyzer Specifications (requires option 006)

### Frequency span/resolution Bandwidth (coupled)

| Span      | Bandwidth |
|-----------|-----------|
| < 50 kHz  | 300 Hz    |
| < 200 kHz | 1 kHz     |
| < 1.5 MHz | 3 kHz     |
| ≤ 4 MHz   | 30 kHz    |

|  |  |
|--|--|
| <b>Display:</b>  | Log, 10 dB/div   |
| <b>Display range:</b>  | 80 dB  |
| <b>Log linearity:</b>  | ± 1.1 dB   |
| <b>Reference level range for (RF In/Out connector):</b>  | +44 to -24 dBm (880 to 960 MHz)<br>+35 to -45 dBm (1710 to 1990 MHz) |
| <b>Non-harmonic spurious responses:</b>  | -50 dBc max, for inputs ≤ 30 dBm                                     |
| <b>Residual responses:</b>   | < -70 dBm (no input signal, 0 dB attenuation)                        |
| <b>Image rejection:</b>  | > 50 dB  |
| <b>In PCS1900 band only the ORFS and Spectrum Analyzer specifications do not apply over this range</b> | 1904 to 1906 MHz, corresponding to ARFCN 781 to 791                  |

### *Supplemental characteristics*

|  |   |
|--|---|
| <b><i>Level accuracy:</i></b>                | ± 2.5 dB                                      |
| <b><i>Frequency overrange:</i></b>           | To 1015 MHz (GSM900, E-GSM900)                |
| <b><i>Displayed average noise level:</i></b> | < -116 dBm (0 dB attenuation, < 50 kHz spans) |

### *Frequency span/resolution Bandwidth (coupled)*

| <i>Span</i> | <i>Bandwidth</i> |
|-------------|------------------|
| ≤ 50 MHz    | 30 kHz           |

---

## Audio Source Specifications

### Frequency

**Range:** DC to 25 kHz  
**Accuracy:** 0.025% of setting

### *Supplemental characteristics*

**Minimum resolution:** 0.1 Hz

### Output level

**Range:** 0.1 mV to 4 V<sub>rms</sub>  
**Maximum output current:** 20 mA peak  
**Output impedance:** < 1 ohm  
**Accuracy:** ± (2% of setting + resolution)  
**Residual distortion (THD + noise, amplitude > 200 mV<sub>rms</sub>):** 0.1%, 20 Hz to 25 kHz in 80 kHz BW

### *Supplemental characteristics*

**Minimum resolution:**  
*Level ≤ 0.01 V: 50 μV*  
*Level ≤ 0.1 V: 0.5 mV*  
*Level ≤ 1 V: 5 mV*  
*Level > 1 V: 50 mV*

**DC coupled offset:** < 50 mV

---

## Audio Analyzer Specifications

### Frequency measurement

|                        |  |
|------------------------|--|
| <b>Range:</b>          | 20 Hz to 400 kHz   |
| <b>Accuracy:</b>       | $\pm (0.02\% + 1 \text{ count} + \text{reference accuracy})$ |
| <b>External input:</b> | 20 mV <sub>rms</sub> to 30 V <sub>rms</sub>                  |

### *Supplemental characteristics*

|                            |  |
|----------------------------|--|
| <b>Minimum resolution:</b> | $f < 10 \text{ kHz}: 0.01 \text{ Hz}$<br>$f < 100 \text{ kHz}: 0.1 \text{ Hz}$<br>$f \geq 100 \text{ kHz}: 1 \text{ Hz}$ |
|----------------------------|--|

### AC voltage measurement

|   |                            |
|---|----------------------------|
| <b>Voltage range:</b>   | 0 V to 30 V <sub>rms</sub> |
| <b>Accuracy (20 Hz to 15 kHz),<br/>input &gt; 1 mV<sub>rms</sub>:</b> | $\pm 3\%$ of reading       |
| <b>Residual noise + THD (15 kHz BW):</b>                              | 175 $\mu$ V                |

### *Supplemental characteristics*

|                            |   |
|----------------------------|---|
| <b>3 dB bandwidth:</b>     | 2 Hz to 100 kHz   |
| <b>Input impedance:</b>    | 1 Mohm, 145 pF at audio in  |
| <b>Minimum resolution:</b> | 4 digits for inputs $\geq 100 \text{ mV}$<br>3 digits for inputs $< 100 \text{ mV}$ |

### DC voltage measurement

|                       |                                      |
|-----------------------|--------------------------------------|
| <b>Voltage range:</b> | 100 mV to 42 V                       |
| <b>Accuracy:</b>      | $\pm (1.0\%$ of reading + DC Offset) |
| <b>DC offset:</b>     | $\pm 45 \text{ mV}$                  |

### *Supplemental characteristics*

|                            |        |
|----------------------------|--------|
| <b>Minimum resolution:</b> | 1.0 mV |
|----------------------------|--------|

### Distortion measurement

|  |   |
|--|---|
| <b>Fundamental frequency:</b>            | 1 kHz $\pm$ 5 Hz                            |
| <b>Input level range:</b>                | 30 mV <sub>rms</sub> to 30 V <sub>rms</sub> |
| <b>Display range:</b>                    | 0.1% to 100%                                |
| <b>Accuracy:</b>                         | $\pm$ 1 dB (0.5 to 100% distortion)         |
| <b>Residual THD + noise (15 kHz BW):</b> | The greater of -60 dB or +175 $\mu$ V       |

### *Supplemental characteristics*

|                                   |                         |
|-----------------------------------|-------------------------|
| <b><i>Minimum resolution:</i></b> | <i>0.01% distortion</i> |
|-----------------------------------|-------------------------|

### Audio filters

There are seven audio filters used in the HP/Agilent 8922 test set.

50 Hz HPF, 300 Hz HPF, 300 Hz LPF, 3 kHz LPF, 15 kHz LPF, 750  $\mu$ s de-emphasis, 1 kHz notch.

### Audio detectors

**The audio detectors available in the HP/Agilent 8922 are:**

Pk+, pk-, pk + hold, pk - hold, pk  $\pm$ /2, pk  $\pm$ /2 hold, pk  $\pm$  max, pk  $\pm$  max hold, RMS

---

## Oscilloscope Specifications

|  |  |
|--|--|
| <b>Frequency range (3 dB):</b>               | 2 Hz to 50 kHz                               |
| <b>Scale/division:</b>                       | 10 mV to 10 V in 1, 2, 5 and 10 steps        |
| <b>Amplitude accuracy (20 Hz to 10 kHz):</b> | $\pm 1.5\%$ of reading $\pm 0.1$ division    |
| <b>Time/division:</b>                        | 10 $\mu$ s to 100 ms in 1, 2, 5 and 10 steps |
| <b>External trigger level:</b>               | TTL  |
| <b>Maximum voltage Scope in:</b>             | 5 V <sub>peak</sub>                          |
| <b>Audio in:</b>                             | 30 V <sub>rms</sub>                          |

### *Supplemental characteristics*

|                                   |   |
|-----------------------------------|---|
| <b><i>3 dB bandwidth:</i></b>     | <i>Typically &gt; 100 kHz</i>   |
| <b><i>Internal DC offset:</i></b> | <i><math>\leq 0.1</math> division for <math>\geq 50 \mu</math>V/div sensitivity</i> |

---

## Remote programming

|                               |   |
|-------------------------------|---|
| <b>GPIB:</b>                  | IEEE Standard 488.2   |
| <b>Functions implemented:</b> | SH1, AH1, T6, L4, SR1, RL1, LE0, TE0,<br>PP0, DC1, DT1, C4, C11, E2 |
| <b>RS-232:</b>                | 3 wire RJ-11 connector used for serial<br>data transfer             |
| <b>Baud rates:</b>            | 150, 300, 600, 1200, 2400, 4800, 9600,<br>and 19200 selectable      |

---

## Printer Support

### RS-232:

3 wire RJ-11 connector used for serial data transfer

### Parallel Port

This port is used with printers requiring a parallel interface when printing. Use address 15 when sending data to this port from IBASIC Programs

Pin assignments are as follows;

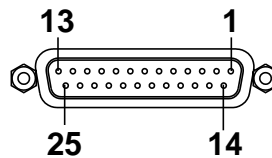

- 1 nStrobe
- 2 Data 1 (Least Significant Bit)
- 3 Data 2
- 4 Data 3
- 5 Data 4
- 6 Data 5
- 7 Data 6
- 8 Data 7
- 9 Data 8 (Most Significant Bit)
- 10 nAck
- 11 Busy
- 12 PError
- 13 Select
- 14 nAutoFd
- 15 nFault
- 16 nInit
- 17 nSelectIn
- 18 Signal Ground (nStrobe)
- 19 Signal Ground (Data 1 and Data 2)
- 20 Signal Ground (Data 3 and Data 4)
- 21 Signal Ground (Data 5 and Data 6)
- 22 Signal Ground (Data 7 and Data 8)
- 23 Signal Ground (Busy and nFault)
- 24 Signal Ground (PError, Select and nAck)
- 25 Signal Ground (nAutoFd, nSelectIn and nInit)

---

## General Specifications

|                               |   |
|-------------------------------|---|
| <b>Size:</b>                  | HP 8922 + HP 83220: 310H x 426W x 574D mm (12.25 x 16.75 x 23 inch)                                       |
| <b>Weight:</b>                | HP/Agilent 8922 + HP/Agilent 83220:<br>48.8 kg, 107 lbs   |
| <b>Operating temperature:</b> | 0 <sup>0</sup> to +55 <sup>0</sup> C  |
| <b>Storage temperature:</b>   | -40 <sup>0</sup> to +70 <sup>0</sup> C  |
| <b>Power:</b>                 | 100, 120, 220, 240 Vac, 48 to 440 Hz<br>± 12% of line voltage, approximately<br>640 VA                    |
| <b>Video output:</b>          | The video out connector on the rear panel<br>outputs a 15 kHz PAL CVBS<br>underscanning compatible signal |

---

**NOTE:**

For details about general specifications, refer to the appropriate sections in the *HP/Agilent 8922 User's Guide* or *HP/Agilent 83220A/E User's Guide*.



---

## Reference Specifications

The accuracy needs for testing GSM radios require the unit to be operated with the high stability reference (option 001) or an external high stability reference.

|  |  |
|--|--|
| <b>Accuracy (after warm up):</b>           | $\pm$ [(Time since calibration $\times$ aging rate) + temperature effects + accuracy of calibration] |
| <b>External reference input Frequency:</b> | 13, 10, 5, 2 or 1 MHz, $\pm$ 30 ppm  |
| <b>Level:</b>                              | 0 to +10 dBm   |

### *Supplemental characteristics*

|   |                    |
|---|--------------------|
| <b>Nominal impedance:</b>                 | 50 ohm             |
| <b>10 MHz out (rear panel BNC) Level:</b> | > +8.0 dBm nominal |
| <b>Impedance:</b>                         | 50 ohm nominal     |
| <b>13 MHz out (rear panel BNC) Level:</b> | > +8.0 dBm nominal |
| <b>Impedance:</b>                         | 50 ohm nominal     |

### Fixed reference mode

|                               |  |
|-------------------------------|--|
| <b>Aging:</b>                 | < 2 ppm/year                                 |
| <b>Temperature stability:</b> | $\pm$ 1 ppm (0° to 55°C)                     |
| <b>Warm-up time:</b>          | < 30 minutes, $\pm$ 2 ppm of final frequency |

### Tunable reference mode

This allows offsetting the internal reference by a selected amount relative to the high stability reference (option 001) or an external reference.

|  |   |
|--|---|
| <b>Required external reference accuracy:</b> | $\pm$ 0.5 ppm   |
| <b>Tune range:</b>                           | $\pm$ 30 ppm  |
| <b>Reference accuracy:</b>                   | $\pm$ 1 ppm + accuracy of external reference or high stability (option 001) |
| <b>Temperature stability:</b>                | $\leq$ 4 ppm, for selected offsets of up to $\pm$ 30 ppm                    |



---

**How To Return Equipment for Repair**

---

## Return Procedure

If you need to return your HP/Agilent 8922 or HP/Agilent 83220 to Agilent Technologies, first obtain the correct Service Center shipping address from your local sales office and carry out the following procedure.

Refer to ‘Sales and Service Offices’ on page 79 for contact information.

---

**CAUTION:**

---

Instrument damage can result from using packaging materials other than the original shipping materials or equivalent. Never use styrene pellets as packaging materials. They do not adequately cushion the instrument, do not prevent it from shifting in the carton, and can cause instrument damage due to ESD.

- 1 Please send the following information with the returned instrument:
  - a Type of service required.
  - b Description of the problem and whether it is constant or intermittent.
  - c Name and phone number of technical contact person.
  - d Return address.
  - e Model number of returned instrument.
  - f Full serial number of returned instrument.
  - g List of any accessories returned with instrument
- 2 Send copies of any performance data recorded for the instrument.
- 3 Pack the instrument in the original shipping materials or the equivalent.
- 4 If the original shipping materials are not available, follow these steps to repackage the instrument for shipment:
  - a Wrap the instrument in antistatic plastic to reduce the possibility of ESD-caused damage.
  - b Obtain a double-walled, corrugated cardboard carton of 159 kg (350 lb) test strength. The carton must be large enough and strong enough to accommodate the instrument. Allow at least 7 to 10 cms on all sides of the instrument for packing material.
  - c Surround the instrument with 7 to 10 cms of packing material to protect it and prevent it from moving in the carton.
- 5 Seal the carton with strong nylon adhesive tape.
- 6 Mark the carton "FRAGILE, HANDLE WITH CARE."
- 7 Retain copies of all shipping papers.

---

## Sales and Service Offices

Any adjustment, maintenance, or repair of this product must be performed by qualified personnel. Contact your customer engineer through your local Agilent Technologies Service Center. You can find a list of local service service representatives on the web at:

<http://www.agilent-tech.com/services/English/index.html>

You can also contact one of the following centers and ask for a test and measurement sales representative.

### **Asia Pacific:**

Agilent Technologies  
19/F, Cityplaza One, 1111 King's Road,  
Taikoo Shing, Hong Kong, SAR  
(tel) (852) 2599 7889  
(fax) (852) 2506 9233

### **Japan:**

Agilent Technologies Japan Ltd.  
Measurement Assistance Center  
9-1, Takakura-Cho, Hachioji-Shi  
Yokyo, 192-8510  
(tel) (81) 426 56 7832  
(fax) (81) 426 56 7840

### **Australia/New Zealand:**

Agilent Technologies Australia Pty Ltd  
347 Burwood Highway  
Forest Hill, Victoria 3131  
(tel) 1-800 629 485 (Australia)  
(fax) (61 3) 9272 0749  
(tel) 0 800 738 378 (New Zealand)  
(fax) (64 4) 802 6881

**Canada**

Agilent Technologies Canada Inc.  
5150 Spectrum Way,  
Mississauga, Ontario  
L4W 5G1  
(tel) 1 877 894 4414

**Europe:**

Agilent Technologies  
Test & Measurement  
European Marketing Organisation  
P.O. Box 999  
1180 AZ Amstelveen  
The Netherlands  
(tel) (31 20) 547 9999

**Latin America:**

Agilent Technologies  
Latin American Region Headquarters  
5200 Blue Lagoon Drive, Suite #950  
Miami, Florida 33126  
U.S.A.  
(tel) (305) 267 4245  
(fax) (305) 267 4286

**United States:**

Agilent Technologies  
Test and Measurement Call Center  
P.O. Box 4026  
Englewood, CO 80155-4026  
(tel) 1 800 452 488

In any correspondence or telephone conversations, refer to the power instrument by its model number and full serial number. With this information, the Agilent Technologies representative can quickly determine whether your unit is still within its warranty period.

---

**Appendix A - Establishing Absolute GSM BCH  
Power Level**

---

## Procedure

The following procedure can be used for determining the absolute GSM BCH peak power level. The GSM BCH power level is the output from the RF In/Out port along with the TCH. This output is used to synchronize calls when switching from E-GSM900 to DCS1800 (Dual Band mode).

It is assumed that the operator is familiar with operating the HP/Agilent 8922 Multi-Band Test System and HP/Agilent 8560 Series Spectrum Analyzers.

## Equipment

- HP/Agilent 8922 Multi-Band Test System
- HP/Agilent 8560 Series Spectrum Analyzer
- N-type to N-type cable

## Equipment Set up

- Ensure the coupled RF In/Out has a 50 Ohm load connected.
- Connect the HP/Agilent 8922 Multi-Band Test System and ensure the system is operational.
- Connect the Spectrum Analyzer to the HP/Agilent 8922 Multi-Band Test System using the N-type connecting cable. Connect from the HP/Agilent 8922 Multi-Band Test System RF In/Out port to the Input port of the spectrum analyzer.
- Switch on all instruments, allowing 30 minutes warm up time.

## HP/Agilent 8922 Set up Procedure

- 1 Select **CONFIG** screen.
- 2 Ensure the **Compatible** mode is set to **8922P** or **8922X**. If the mode is not at either of these settings, change this field and switch the system off then on again.
- 3 From the Cell Status screen, set the **OPERATING MODE** to **E-GSM**.
- 4 Set the **OPERATING MODE** (second field) to **TEST MODE**.
- 5 From the **CONTROL** menu, set the **Broadcast On Channel** to **20** (939 MHz).
- 6 Set the **Dual Band** field to **ON/OFF** (This will change the **OPERATING MODE** to **DCS1800, Dual Band**).



- 7 Set the **Traffic Chan** field to **ON/OFF**. This will remove the pulsing from the BCH channel.
- 8 On the front panel of the HP/Agilent 8922, press **CELL CONFIG** to select to Cell Configuration screen.
- 9 Set the **GSM BCH Atten.** field to **0 dB**.
- 10 Change the top left field to **Settable**. This will change the BCH modulation to all 1's.
- 11 On the front panel of the HP/Agilent 8922, press Press **SHIFT** **CELL CNTL** (**RFG/RFA**).
- 12 From the **Mod Source** menu set the **GMSK** field to **Off**. This will turn the BCH modulation off, so that the BCH is a clean CW signal.

### HP/Agilent 8560 Series Set up and Measurement

- 1 Set the spectrum analyzer test frequency.
  - a Press **FREQUENCY** key.
  - b Press softkey **CENTER FREQ** and enter 939 MHz ( **9** **3** **9** **MHz -dBm sec** )
- 2 Set the spectrum analyzer test span.
  - a Press **SPAN** key.
  - b Press softkey **SPAN** and enter 1 MHz ( **1** **MHz -dBm sec** )
- 3 Set the spectrum analyzer attenuation and reference level.
  - a Press **AMPLITUDE** key.
  - b Press softkey **ATTEN** to change setting to **MAN**.
  - c Enter 0 dB ( **0** **GHz +dBm dB** )
  - d Press softkey **REF LVL**, then using the arrow keys ( **↓** **↑** ), move the signal peak to the highest graticule. Change the graticule scale if necessary.

---

#### WARNING:



---

Once these settings have been made, the spectrum analyzer is now vulnerable to overload damage.

- 4 To obtain a peak GSM BCH power level value, press **PEAK SEARCH** and read the value given at the top of the spectrum analyzer display.

## Appendix A - Establishing Absolute GSM BCH Power Level Procedure

### To enhance this measurement

- 1 Press **SWEEP**.
- 2 Press softkey **SWP TIME** and change to **MAN**.
- 3 Enter 10 Seconds ( **1** **0**  ).
- 4 Press **BW**.
- 5 Press softkey **RES BW** and change to **MAN**.
- 6 Enter 30 KHz ( **3** **0**  ).
- 7 Press softkey **VIDEO BW** and change to **MAN**.
- 8 Enter 10 Hz ( **1** **0**  ).
- 9 To obtain a new peak GSM BCH power level value, press **PEAK SEARCH** and read the value given at the top of the spectrum analyzer display.

---

## Index

---

### Numerics

1710-1990 MHz Aux RF In Port, 5

### A

Absolute GSM BCH power level, 82  
amplitude downlink, 28  
Assign/Handover, 26  
assignment, 17  
Aux RF In/Out Port, 5

### C

Calibration Routine, 7  
  RAM Initialize, 8  
  when required, 7  
call termination, 20  
Cell Configuration  
  GPIB commands, 34  
  screen, 22  
Cell Counts, 30  
Cell Status - Test Mode  
  screen, 24  
changing band, 17  
Channel, 27  
  ARFCN, 27  
  dual band screen, 27  
Configure  
  compatibility mode, 25  
  screen, 25  
Connection  
  check list, 2  
  failure, 3  
  overview, 1  
  rear panel, 6  
  Warnings, 2  
connectors  
  Parallel Port, 73  
Coupled RF In/Out Port, 5  
Current Band  
  dual band screen, 27

### D

default start up, 8, 14  
Downlink Amplitude, 37  
Dual Band  
  control screen, 26  
  GPIB control subsystem, 36  
  test mode, 24

### E

end a call, 20  
Error Screen, 31  
establish a call, 15  
Examples of GPIB, 39  
Execute  
  dual band screen, 29  
  GPIB command, 38

### G

GPIB Commands, 33  
  cell configuration subsystem, 34  
  Downlink Amplitude, 37  
    GSM BCH, 37  
    TCH, 37  
  Dual Band Control Subsystem, 36  
  Examples, 39  
  MS Information Subsystem, 34  
  Multi-Band Report, 34  
  power class, 35  
    DCS, 35  
    GSM, 35  
  RF Input Level, 37  
  Test Mode, 38  
  Traffic Channel, 37  
  TX Power Level  
    DCS, 37  
    E-GSM, 37

### H

handover, 18  
Help Screen, 31  
How to  
  change band, 17  
  end a call, 20  
  establish a call, 15  
  make measurements, 16, 19  
  power-up, 14  
HP/Agilent 83220  
  Aux RF In Port, 5  
  Aux RF Out Port, 5  
  Coupled RF In/Out Port, 5  
  front panel diagram, 6  
  IF Link Port, 4  
  rear panel connection, 6  
  RF In/Out Port, 5  
HP/Agilent 8922

IF Link Port, 4  
  rear panel connection, 6

### I

IF Link Cable, 4  
IF Link Port, 4  
Input Level, 29  
  RF Analyzer, 29  
instrument returns, 77

### L

Level Control, 29

### M

making measurements, 16, 19  
Mobile Reports  
  dual band screen, 30  
Mobile Status  
  dual band screen, 30  
MS Information  
  GPIB subsystem, 34  
  screen, 32  
MS Test Port, 5  
Multi-Band  
  report, cell configuration screen, 22  
  testing  
    coupled RF In/Out port, 5  
    GPIB Commands, 33

### P

Parallel Port  
  connector, 73  
power class  
  GPIB command, 35  
    DCS, 35  
    GSM, 35  
  screen field, 32  
Power Level  
  dual band screen, 30  
  GPIB command  
    DCS, 37  
    E-GSM, 37  
power-up, 14  
problems  
  establishing a call, 15  
  instrument returns, 77  
  power up, 14

---

## Index

---

- Procedure  
absolute GSM BCH power level, 82
- R**
- RAM Initialize, 8  
offset calibration value, 8
- Rear Panel Connections, 6  
return for repair, 77
- RF analyzer input, 38  
level control, 38
- RF In/Out Path Diagram, 6
- RF In/Out Port, 5
- RF Input Level, 37  
GPIB command  
DCS, 37  
E-GSM, 37
- S**
- Screens
- Cell Configuration, 22
    - Mutli-Band report, 22
  - Cell Status - Test Mode, 23, 24
    - dual band mode, 24
  - Configure, 25
  - Dual Band Control, 26
    - channel
      - current, 27
      - execute a change, 29
      - moving, 26
      - selecting, 27
    - downlink amplitude, 28
    - input level, 29
  - Error, 31
  - Help, 31
  - MS Information/Signalling, 32
- service latch, 8, 14
- Setting Up  
calibration routine, 7  
procedure, 7
- Specifications, 45
- 0.3 GMSK Data Recovery, 63
  - 0.3 GMSK Modulation, 52
  - 1710 to 1990 MHZ Aux RF Out Connector, 51
  - 30 dB Pulse Modulation, 54
  - Amplitude Envelope Measurement, 61
  - Audio Analyzer, 69
  - Audio Source, 68
  - Aux RF Out Connector, 50
  - CW RF Frequency Measurement, 56
  - CW RF Power Measurement, 57
  - FM Demodulation Output, 64
  - General, 74
  - GSM Functionality, 47
  - Oscilloscope, 71
  - Output RF Spectrum Measurement, 66
  - Peak Transmitter Carrier Power Measurement, 58
  - Phase and Frequency Measurement, 62
  - Printer Support, 73
  - Pulse Demodulation Output, 65
  - Pulse Modulation, 53
  - Pulse on/off Ratio Measurement, 60
  - Reference, 75
  - Remote Programming, 72
  - RF Analyzer, 55
  - RF Generator, 48
  - Spectrum Analyzer, 67
  - start up mode, 8
  - System Calibration, 7
- T**
- Traffic Channel
- DCS, 37
  - display current, 27
  - EGSM, 37
  - Execute, 29
  - handover, 26, 38
- TX Level, 30
- TX Power Level
- DCS, 37
  - EGSM, 37