



# Microwave Landing System MLS-800 Operation Manual

Issue-3

**EXPORT CONTROL WARNING:** This document contains controlled technology or technical data under the jurisdiction of the Export Administration Regulations (EAR), 15 CFR 730-774. It cannot be transferred to any foreign third party without the specific prior approval of the U.S. Department of Commerce Bureau of Industry and Security (BIS). Violations of these regulations are punishable by fine, imprisonment, or both.

# **OPERATION MANUAL**

## **MICROWAVE LANDING SYSTEM TEST SET**

### **MLS-800-2**

PUBLISHED BY  
Aeroflex

COPYRIGHT © Aeroflex 2004

All rights reserved. No part of this publication may be reproduced, stored in a retrieval system, or transmitted in any form or by any means, electronic, mechanical, photocopying, recording or otherwise without the prior permission of the publisher.

Original Printing	May 2002
Issue-2	Oct 2004
Issue-3	May 2009

10200 West York / Wichita, Kansas 67215 U.S.A. / (316) 522-4981 / FAX (316) 524-2623

**Subject to Export Control, see Cover Page for details.**

**SAFETY FIRST: TO ALL OPERATIONS PERSONNEL**

**REFER ALL SERVICING OF UNIT TO QUALIFIED TECHNICAL PERSONNEL. THIS UNIT CONTAINS NO OPERATOR SERVICEABLE PARTS.**

**WARNING: USING THIS EQUIPMENT IN A MANNER NOT SPECIFIED BY THE ACCOMPANYING DOCUMENTATION MAY IMPAIR THE SAFETY PROTECTION PROVIDED BY THE EQUIPMENT.**

**CASE, COVER OR PANEL REMOVAL**

Removing the Chassis Assembly from the Case Assembly exposes the operator to electrical hazards that can result in electrical shock or equipment damage. Do not operate this Test Set with the Chassis Assembly removed from the Case Assembly.

**SAFETY IDENTIFICATION IN TECHNICAL MANUAL**

This manual uses the following terms to draw attention to possible safety hazards, that may exist when operating or servicing this equipment.

**CAUTION:** THIS TERM IDENTIFIES CONDITIONS OR ACTIVITIES THAT, IF IGNORED, CAN RESULT IN EQUIPMENT OR PROPERTY DAMAGE (E.G., FIRE).

**WARNING:** THIS TERM IDENTIFIES CONDITIONS OR ACTIVITIES THAT, IF IGNORED, CAN RESULT IN PERSONAL INJURY OR DEATH.

**SAFETY SYMBOLS IN MANUALS AND ON UNITS**

**CAUTION:** Refer to accompanying documents. (This symbol refers to specific CAUTIONS represented on the unit and clarified in the text.)



**AC OR DC TERMINAL:** Terminal that may supply or be supplied with ac or dc voltage.



**DC TERMINAL:** Terminal that may supply or be supplied with dc voltage.



**AC TERMINAL:** Terminal that may supply or be supplied with ac or alternating voltage.



**DANGEROUS VOLTAGE:** Indicates electrical shock hazard due to high voltage levels.

**EQUIPMENT GROUNDING PRECAUTION**

Improper grounding of equipment can result in electrical shock.

**USE OF PROBES**

Check the specifications for the maximum voltage, current and power ratings of any connector on the Test Set before connecting it with a probe from a terminal device. Be sure the terminal device performs within these specifications before using it for measurement, to prevent electrical shock or damage to the equipment.

**POWER CORDS**

Power cords must not be frayed, broken nor expose bare wiring when operating this equipment.

**USE RECOMMENDED FUSES ONLY**

Use only fuses specifically recommended for the equipment at the specified current and voltage ratings.

**INTERNAL BATTERY**

This unit contains a Sealed-Lead Battery, serviceable only by a qualified technician.

**CAUTION:** SIGNAL GENERATORS CAN BE A SOURCE OF ELECTROMAGNETIC INTERFERENCE (EMI) TO COMMUNICATION RECEIVERS. SOME TRANSMITTED SIGNALS CAN CAUSE DISRUPTION AND INTERFERENCE TO COMMUNICATION SERVICES OUT TO A DISTANCE OF SEVERAL MILES. USERS OF THIS EQUIPMENT SHOULD SCRUTINIZE ANY OPERATION THAT RESULTS IN RADIATION OF A SIGNAL (DIRECTLY OR INDIRECTLY) AND SHOULD TAKE NECESSARY PRECAUTIONS TO AVOID POTENTIAL COMMUNICATION INTERFERENCE PROBLEMS.



THIS PAGE INTENTIONALLY LEFT BLANK.



## TABLE OF CONTENTS

Title	Chapter/Section
Title / Copyright Page	
Safety Page	
Table of Contents	
Introduction	
<b>Chapter 1</b>	
Description	1-1
Operation	1-2
Specifications	1-3
Shipping	1-4
Storage	1-5
Appendix A - Connector Pin-Out Tables	
Appendix B - MLS-800-2 Timing Sequences	
Appendix C - Channel Frequencies	
Appendix D - PFE and CMN Filter Definitions	
Appendix E - Metric/British Imperial Conversion Table with Nautical Distance Conversions	
Appendix F - Auxiliary Equipment	
Appendix G - MLS-800-2 Approach Azimuth Beam Board Data	
Appendix H - Abbreviations	
Index	



THIS PAGE INTENTIONALLY LEFT BLANK.



## **INTRODUCTION - MLS-800-2 MICROWAVE LANDING SYSTEM TEST SET**

This manual contains the information necessary to install, operate and evaluate the MLS-800-2 Microwave Landing System Test Set.

It is strongly recommended that personnel be thoroughly familiar with the contents of this manual before attempting to operate this equipment.

### **ORGANIZATION**

This manual is divided into the following Chapters and Sections:

#### **CHAPTER 1 - OPERATION**

Section 1 - DESCRIPTION (description and functional capabilities)

Section 2 - OPERATION (installation; controls, connectors and indicators; menu definition; performance evaluation; operating procedures; remote operation)

Section 3 - SPECIFICATIONS

Section 4 - SHIPPING

Section 5 - STORAGE



THIS PAGE INTENTIONALLY LEFT BLANK.





**CHAPTER ONE**  
**MLS-800-2 MICROWAVE LANDING SYSTEM TEST SET**  
**OPERATION MANUAL**  
**TABLE OF CONTENTS**

Title	Chapter/Section/Subject	Page
<b>SECTION 1 - DESCRIPTION</b>	<b>1-1</b>	
1. General Description and Capabilities	1-1-1	1
1.1 Description	1-1-1	1
1.2 Functional Capabilities	1-1-1	1
<b>SECTION 2 - OPERATION</b>	<b>1-2</b>	
1. Installation	1-2-1	1
1.1 General	1-2-1	1
1.2 Safety Precautions	1-2-1	1
1.2.1 Complying with Instructions	1-2-1	1
1.2.2 Grounding Requirements	1-2-1	1
1.2.3 Operating Safety	1-2-1	1
1.2.4 CAUTION and WARNING Labels	1-2-1	1
1.3 Installation and Operating Precautions	1-2-1	2
1.4 Ramp Test Installation and Procedure	1-2-1	2
1.5 MLS-800-2 System Interface Installation	1-2-1	2
2. Controls, Connectors and Indicators	1-2-2	1
2.1 Front Panel	1-2-2	3
2.2 Rear Panel	1-2-2	5
3. Menu Definition	1-2-3	1
3.1 Power Up Self Test Menu	1-2-3	1
3.2 Master Menu	1-2-3	2
3.3 Save Page Directory Menu	1-2-3	3
3.4 Test Operational Menu	1-2-3	4
3.5 Diagnostic Menu	1-2-3	22
3.6 Special Function Menu	1-2-3	25
4. Performance Evaluation	1-2-4	1
4.1 General	1-2-4	1
4.2 Power Up Self Test	1-2-4	1
5. Operating Procedures	1-2-5	1
5.1 Keyboard Operating Procedures	1-2-5	1
5.1.1 DATA ENTRY and DATA SLEW Keys	1-2-5	1
5.1.2 Recall Data Page	1-2-5	1
5.1.3 Save Data Page	1-2-5	2
5.1.4 Purge Data Page	1-2-5	2
5.1.5 Write Protect Data Page	1-2-5	3
5.1.6 Delete Data Page	1-2-5	3
5.1.7 SYNC Function	1-2-5	4
5.2 Standard Test Conditions	1-2-5	5
5.3 Diagnostic Menu Operation	1-2-5	6
5.3.1 General	1-2-5	6
5.3.2 CRT Alignment Test	1-2-5	7
5.3.3 RF Channel Test	1-2-5	8
5.3.4 429 Loop Test	1-2-5	8



Title	Chapter/Section/Subject	Page
<b>SECTION 2 – OPERATION (cont)</b>	<b>1-2</b>	
6. Remote Operation	1-2-6	1
6.1 General	1-2-6	1
6.1.1 GPIB Transactions	1-2-6	1
6.1.2 Status and Service Request Transactions	1-2-6	2
6.2 Command and Data Structure	1-2-6	5
6.2.1 ASCII Output Commands to MLS-800-2	1-2-6	5
6.2.2 ASCII Output Command Data Format	1-2-6	5
6.2.3 Return Data Format	1-2-6	6
6.2.4 Command Groups	1-2-6	6
6.2.5 Reply Identifier	1-2-6	6
6.3 Alphabetical Quick Reference ASCII Command Table	1-2-6	7
6.4 Command Set	1-2-6	10
<b>SECTION 3 - SPECIFICATIONS</b>	<b>1-3</b>	
1. General		
1.1 RF Signal Generator	1-3-1	1
1.2 Modulation	1-3-1	2
1.3 Additional Functions	1-3-1	4
1.4 Power	1-3-1	6
<b>SECTION 4 - SHIPPING</b>	<b>1-4</b>	
1. Shipping Test Sets	1-4-1	1
1.1 Information	1-4-1	1
1.2 Repacking Procedure	1-4-1	1
<b>SECTION 5 - STORAGE</b>	<b>1-5</b>	
1. Storing Test Sets	1-5-1	1



## LIST OF ILLUSTRATIONS

Title	Chapter/Section/Subject	Page
MLS-800-2 Ramp Test	1-2-1	3
MLS-800-2 System Interface	1-2-1	3
MLS-800-2 Front and Rear Panels	1-2-2	1
Power Up Self Test Menu	1-2-3	1
Master Menu	1-2-3	2
Save Page Directory Menu	1-2-3	3
Test Operational Menu	1-2-3	4
Diagnostic Menu	1-2-3	22
Special Function Menu	1-2-3	25
Repacking Procedure	1-4-1	2

## LIST OF TABLES

Title	Chapter/Section/Subject	Page
Auxiliary Data Word Parity Combinations	1-2-3	20
Sync Function Keystrokes	1-2-5	4
Status Bit Definition	1-2-6	2
MLS-800-2 GPIB Message Interface Definitions	1-2-6	3
Error/Status Conditions	1-2-6	21
Oscilloscope Sync Amplitude	1-3-1	5



THIS PAGE INTENTIONALLY LEFT BLANK

## SECTION 1 - DESCRIPTION

### 1. GENERAL DESCRIPTION AND CAPABILITIES

#### 1.1 DESCRIPTION

The MLS-800-2 is a microprocessor controlled Ground Station Simulator designed to operate from a bench test environment. Test parameters are selected via 44-position Keyboard and displayed on Test Operational Menus.

There are five menus in the MLS-800-2 system:

- Master Menu
- Test Operational Menu
- Diagnostic Menu
- Special Function Menu
- Save Page Directory Menu

#### 1.2 FUNCTIONAL CAPABILITIES

- Complete Mainpath Simulation:  
Approach (AZ) and High Rate Azimuth (HiAZ)  
Elevation (EL)  
Back Azimuth (BAZ)  
Flare (FL)
- Complete Multipath (MP) Simulation Capability:  
Interference Pulses  
Selectable Fade Rate Modulation of 0.05, 1 and 1000 Hz
- Control of All Beam Parameters:  
Angular Position  
Beam Amplitude Referenced to the Preamble  
Norm and Half Width Pulse  
Selectable Beam Width at 0.5°, 1°, 2°, 3°, 4° or 5°
- Sync Capability for:  
External Monitoring  
Designating PFE and CMN Function  
Designating Multipath Function
- Preamble Parity, Symmetry and Percent Update
- Simulates all Basic Data Words plus Auxiliary Data Words with Parity Selection
- Full Range of MLS Channels
- OCI Control for Right (RT), Left (LT) and Rear (RR)
- 75 dB AZ to EL Ratio Capability  
Propeller/Rotor Modulation at 1 to 100 Hz  
Variable in 1 Hz steps Morse Code Identification Capability
- ARINC 429 Receiver with PFE and CMN calculations
- External RF Reference Input
- Clearance Pulse Simulation
- 6.75 Hz Modulation
- IEEE-488-1978 Interface for Remote Control Operation



THIS PAGE INTENTIONALLY LEFT BLANK.

## SECTION 2 - OPERATION

### 1. INSTALLATION

#### 1.1 GENERAL

STEP	PROCEDURE
1.	Set Test Set into vertical or horizontal operating position, with lid removed.
2.	Connect MLS Receiver to RF OUT Connector.
	<b>NOTE:</b> When performing complete Loop Test on MLS Receiver, connect UUT to RF OUT Connector and ARINC 429 BUS Connector.
3.	Furnish electrical power to Test Set as follows:
	<b>External AC Power</b>
	Connect furnished AC Power Cable between 103.5 to 240 VAC at 45 to 440 Hz power source and the AC POWER Connector. Set PWR/OFF/ BATT Switch to PWR.
	<b>External dc Power</b>
	Connect furnished DC Power Cable between external DC power source and DC POWER Connector. Set PWR/OFF/BATT Switch to PWR.
	<b>Internal Battery Operation</b>
	Press PWR/OFF/BATT Switch to BATT. (This is a momentary spring-loaded switch to OFF.) When operating Test Set on battery, internal timer interrupts power after approximately ten minutes. Press PWR/OFF/BATT Switch to BATT to restore power.
	<b>NOTE:</b> Low voltage detect circuit switches TEST SET OFF before performance is affected by low battery voltage.

#### 1.2 SAFETY PRECAUTIONS

Listed are several safety precautions which must be observed during installation and operation. Aeroflex assumes no liability for failure to comply with any safety precautions outlined in this manual.

##### 1.2.1 Complying with Instructions

Installation/operating personnel should not attempt to install or operate the Test Set without reading and complying with all instructions contained in this manual. All procedures must be performed in exact sequence and manner described.

##### 1.2.2 Grounding Requirements

To minimize shock hazard, all equipment chassis and cabinets must be connected to electrical ground. All Aeroflex test sets are equipped with a standard three-prong power cable which must be connected to a properly grounded three-prong wall receptacle. It is the customer's responsibility to:

- Have a qualified electrician check wall receptacle(s) for proper grounding.
- Replace any standard two-prong wall receptacle(s) with properly grounded three-prong receptacle(s).

**WARNING: DO NOT USE A THREE-PRONG TO TWO-PRONG ADAPTER PLUG. DOING SO CREATES A SHOCK HAZARD BETWEEN THE CHASSIS AND ELECTRICAL GROUND.**

##### 1.2.3 Operating Safety

Due to presence of potentially lethal voltages within Test Set, operating personnel must not remove top or bottom covers at any time.

##### 1.2.4 CAUTION and WARNING Labels

Extreme care should be exercised when performing any operations preceded by a CAUTION or WARNING label. CAUTION labels appear where possibility of damage to equipment exists and WARNING labels denote conditions where bodily injury or death may result.

### 1.3 INSTALLATION AND OPERATING PRECAUTIONS

- CAUTION:** DO NOT APPLY ANY SIGNALS INTO TEST SET OTHER THAN THOSE DEFINED IN THE OPERATING INSTRUCTIONS.
- CAUTION:** DO NOT OPERATE CRT DISPLAY WITH EXCESSIVE INTENSITY.
- CAUTION:** DO NOT APPLY RF SOURCE TO RF OUT CONNECTOR.
- CAUTION:** TO PROVIDE MAXIMUM PROTECTION OF NON-VOLATILE MEMORY CONTENTS, DO NOT RAPIDLY CYCLE POWER ON AND OFF. ALLOW A MINIMUM OF ONE SECOND BETWEEN ON/OFF CYCLE.
- CAUTION:** ARINC 429 BUS CONNECTOR CONFORMS TO ELECTRICAL SPECIFICATIONS OF ARINC 429 STANDARD.

### 1.4 RAMP TEST INSTALLATION AND PROCEDURE

STEP	PROCEDURE
1.	Connect MLS Test Antenna to Tripod.
2.	Connect coaxial cable from MLS Test Antenna to RF OUT Connector.
3.	Set MLS Test Antenna toward desired receiver location.
4.	Set PWR/OFF/BATT Switch to BATT.
5.	Apply minimum power level necessary to activate MLS Receiver.

### 1.5 MLS-800-2 SYSTEM INTERFACE INSTALLATION

A typical testing interface configuration for MLS Receivers is shown in 1-2-1, Figure 2.

**NOTE:** Refer to MLS Receiver Manufacturer's Manual for specific connector hookup points.



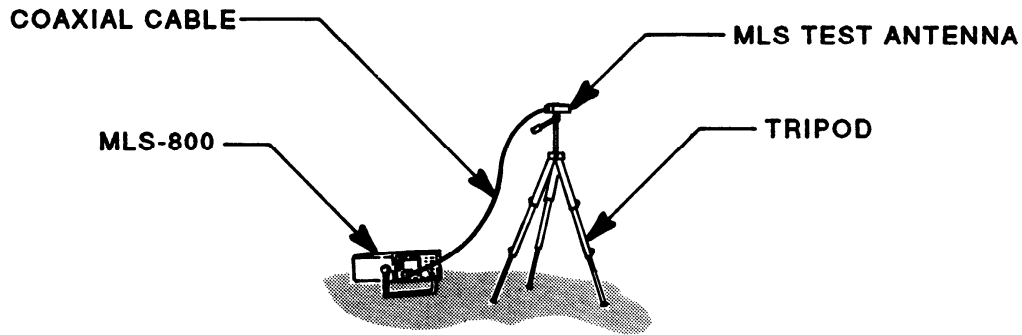
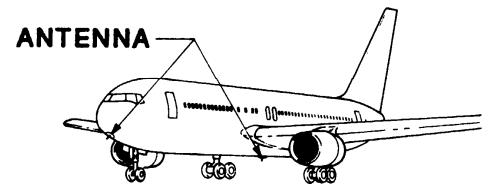

MLS-800-2 Ramp Test  
Figure 1

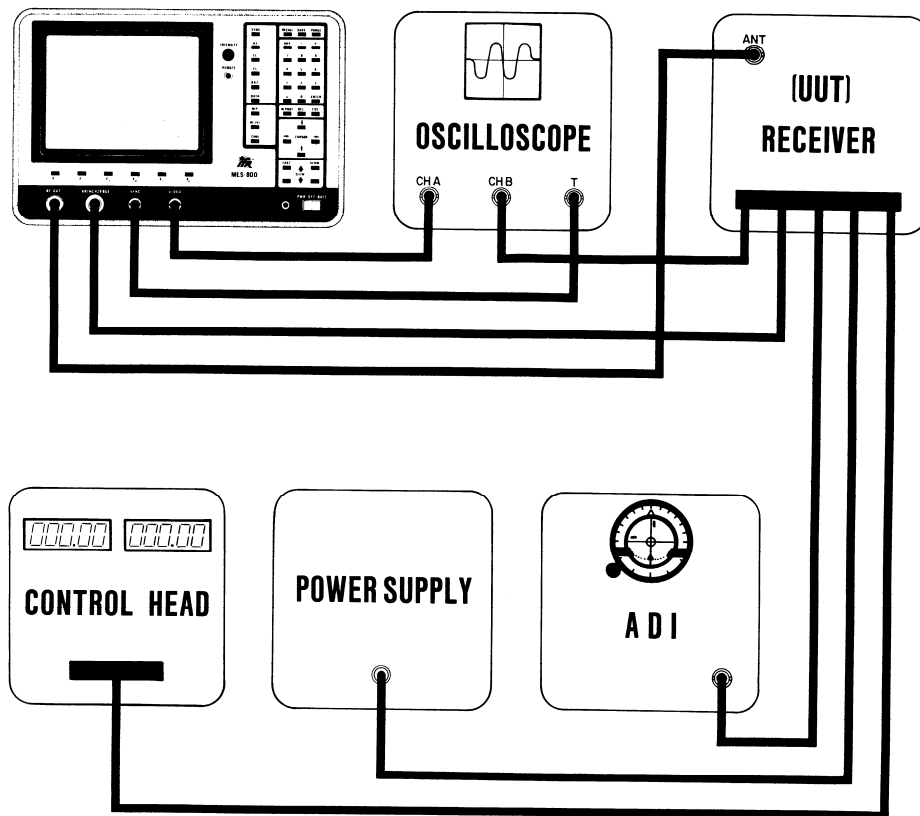

MLS-800-2 System Interface  
Figure 2



THIS PAGE INTENTIONALLY LEFT BLANK

## 2. CONTROLS, CONNECTORS AND INDICATORS

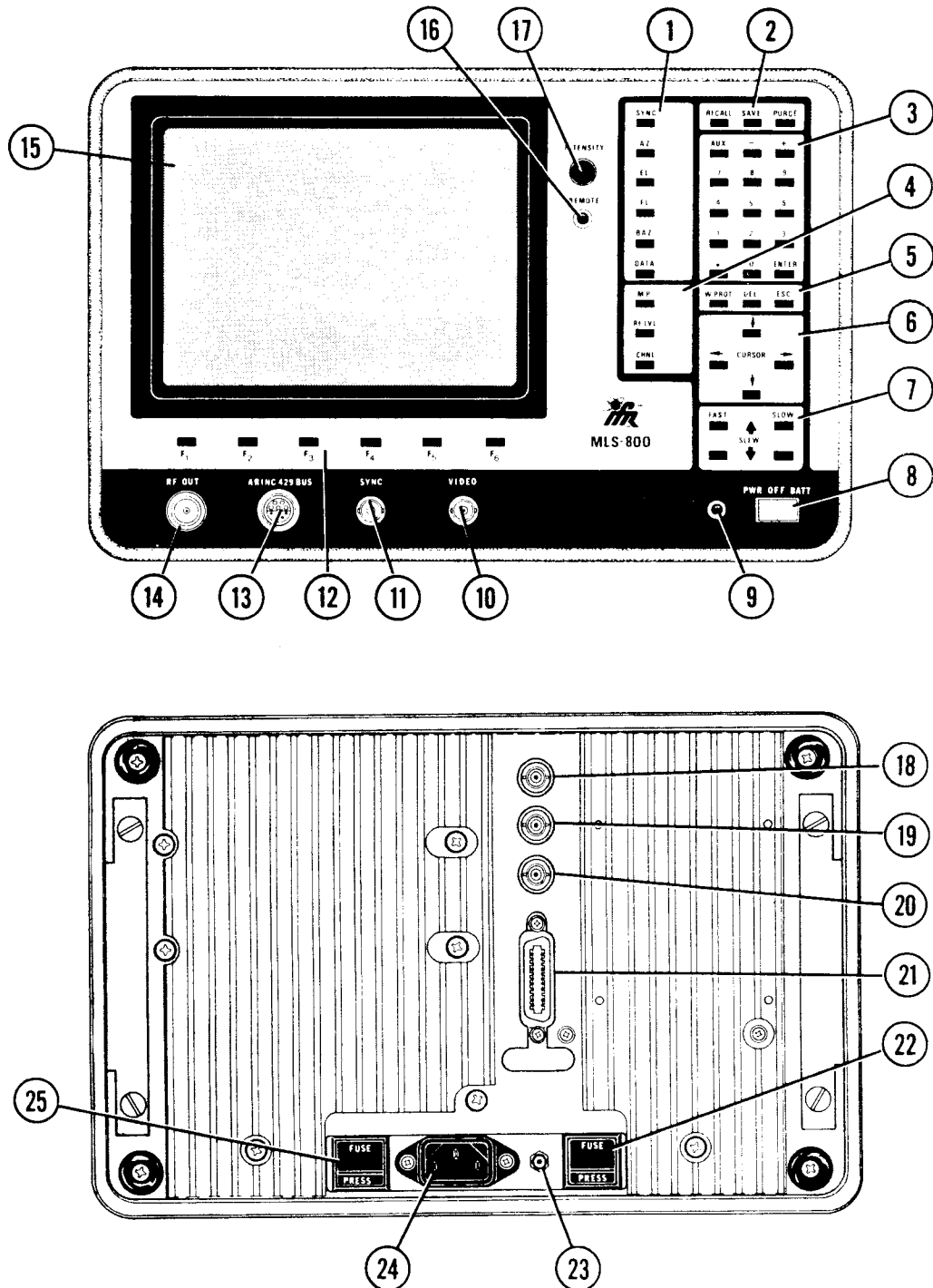

MLS-800-2 Front and Rear Panels  
Figure 3



NUMERICAL LOCATION LIST		ALPHABETICAL LOCATION LIST	
1.	FUNCTION SELECT Keys with Sync	750 MHz RF OUTPUT Connector (J102)	18
2.	STORED DATA Keys	800 MHz VCO +4 OUTPUT Connector (J103)	20
3.	DATA ENTRY Keys	AC LINE Fuse	25
4.	FUNCTION SELECT Keys without Sync	AC POWER Connector	24
5.	DATA CONTROL Keys	ARINC 429 BUS Connector (J703)	13
6.	CURSOR Keys	CURSOR Keys	6
7.	DATA SLEW Keys	DATA CONTROL Keys	5
8.	PWR/OFF/BATT Switch	DATA ENTRY Keys	3
9.	POWER Indicator	DATA SLEW Keys	7
10.	VIDEO OUTPUT Connector (J706)	DC Fuse	22
11.	SYNC OUTPUT Connector (J701)	DC POWER Connector	23
12.	SPECIAL FUNCTION Keys	EXTERNAL REFERENCE INPUT Connector (J103)	19
13.	ARINC 429 BUS Connector (J703)	FUNCTION SELECT Keys with Sync	1
14.	RF OUT Connector (J707)	FUNCTION SELECT Keys without Sync	4
15.	TEST MENU Display	GPIB Connector	21
16.	REMOTE Indicator	INTENSITY Control	17
17.	INTENSITY Control	POWER Indicator	9
18.	750 MHz RF OUTPUT Connector (J102)	PWR/OFF/BATT Switch	8
19.	EXTERNAL REFERENCE INPUT Connector (J103)	REMOTE Indicator	16
20.	800 MHz VCO +4 OUTPUT Connector (J103)	RF OUT Connector (J707)	14
21.	GPIB Connector	SPECIAL FUNCTION Keys	12
22.	DC Fuse	STORED DATA Keys	2
23.	DC POWER Connector	SYNC OUTPUT Connector (J701)	11
24.	AC POWER Connector	TEST MENU Display	15
25.	AC LINE Fuse	VIDEO OUTPUT Connector (J706)	10

## 2.1 FRONT PANEL

ITEM	DESCRIPTION	ITEM	DESCRIPTION
1.	<p><b>FUNCTION SELECT Keys with Sync</b></p> <p>Determines Main Path beam functions addressed by operator and displayed on Test Operational Menu.</p> <p><b>SYNC Key</b></p> <p>Enables sync output at SYNC OUTPUT Connector for AZ, EL, FL, BAZ or Data Word, depending on which Main Path beam function is selected. Sync function enables peripheral functions (Multipath beam, P Parity, Update, Symmetry, PFE and CMN) when SYNC Key is selected.</p> <p><b>AZ Key</b></p> <p>Moves cursor to AZ Angle Field in Beam Control Field of Test Operational Menu.</p> <p><b>EL Key</b></p> <p>Moves cursor to EL Angle Field in Beam Control Field of Test Operational Menu.</p> <p><b>FL Key</b></p> <p>Moves cursor to FL Angle Field in Beam Control Field of Test Operational Menu.</p> <p><b>BAZ Key</b></p> <p>Moves cursor to BAZ Angle Field in Beam Control Field of Test Operational Menu.</p> <p><b>DATA Key</b></p> <p>Selects any Data Word for display on Test Operational Menu.</p>	2.	<p><b>STORED DATA Keys</b></p> <p>Maintains up to 12 Test Operational Menus in Internal Non-Volatile Memory. Stored Test Operational Menus remain in memory, when power is removed, for 10-year life of battery. Stored Test Operational Menus include all non-displayed Data Words.</p> <p><b>RECALL Key</b></p> <p>Recalls stored Test Operational Menu (1 through 12) to TEST MENU Display (15).</p> <p><b>SAVE Key</b></p> <p>Stores Test Operational Menu (1 through 12) to Internal Non-Volatile Memory.</p> <p><b>PURGE Key</b></p> <p>Erases Test Operational Menu (1 through 12) from Internal Non-Volatile Memory.</p> <p>3. <b>DATA ENTRY Keys</b></p> <p>Enters data into Test Operational Menu.</p> <p><b>Value / Polarity Keys</b></p> <p>0 through 9, + and - and decimal (.).</p> <p><b>AUX Key</b></p> <p>Selects Auxiliary Data Words in Test Operational Menu.</p> <p><b>ENTER Key</b></p> <p>Informs processor a key-in sequence is complete.</p>

ITEM	DESCRIPTION	ITEM	DESCRIPTION
4.	<p><b>FUNCTION SELECT</b> Keys without Sync</p> <p>Moves cursor to selected Special Function Data Field on TEST MENU Display.</p> <p><b>MP Key</b></p> <p>Moves cursor to MP Angle Field in Beam Control Field of Test Operational Menu.</p> <p><b>RF LVL Key</b></p> <p>Moves cursor to RF Level Field in Transmission Characteristics Field of Test Operational Menu.</p> <p><b>CHNL Key</b></p> <p>Moves cursor to RF Channel Number in Transmission Characteristics Field of Test Operational Menu.</p> <p><b>NOTE:</b> Refer to Appendix C for a list of ICAO assigned channel numbers.</p>	6.	<p><b>CURSOR</b> Keys</p> <p>Controls movement and position of CRT cursor. Cursor is displayed as blinking reverse video on Test Operational Menu.</p> <p><b>UP (↑) Key</b></p> <p>Moves cursor up Test Operational Menu.</p> <p><b>RIGHT (→) Key</b></p> <p>Moves cursor right on Test Operational Menu.</p> <p><b>DOWN (↓) Key</b></p> <p>Moves cursor down Test Operational Menu.</p> <p><b>LEFT (←) Key</b></p> <p>Moves cursor left on Test Operational Menu.</p>
5.	<p><b>DATA CONTROL</b> Keys</p> <p><b>W PROT Key</b></p> <p>Write Protects Test Operational Menu from being inadvertently overwritten.</p> <p><b>DEL Key</b></p> <p>Deletes each digit of displayed data field one digit at a time before data is entered into Test Operational Menu.</p> <p><b>ESC Key</b></p> <p>Escapes from multiple key sequence to previous data command or field.</p>	7.	<p><b>DATA SLEW</b> Keys</p> <p>Used as an alternate method to DATA ENTRY Keys for changing data within data field.</p> <p><b>FAST SLEW Keys</b></p> <p>Increments/decrements the most significant digits in data field.</p> <p><b>SLOW SLEW Keys</b></p> <p>Increments/decrements the least significant digits in data field.</p>
		8.	<p><b>PWR/OFF/BATT</b> Switch</p> <p>Controls power to MLS-800-2.</p> <p><b>NOTE:</b> Internal battery is continuously charged when external ac or dc power (&gt;15 Vdc) is connected.</p> <p><b>PWR</b></p> <p>MLS-800-2 is powered by external ac or dc power source.</p> <p><b>OFF</b></p> <p>MLS-800-2 is OFF.</p> <p><b>BATT</b></p> <p>MLS-800-2 is powered by internal battery (momentary spring-loaded switch to OFF).</p>

**2.2 REAR PANEL**

ITEM	DESCRIPTION
9.	<p><b>POWER Indicator</b></p> <p>Illuminates when internal or external power is applied.</p>
10.	<p><b>VIDEO OUTPUT Connector (J706)</b></p> <p>Output Connector for Video Detector output (external use).</p>
11.	<p><b>SYNC OUTPUT Connector (J701)</b></p> <p>Output Connector for sync signal to Oscilloscope trigger.</p>
12.	<p><b>SPECIAL FUNCTION Keys</b></p> <p>Functions are defined by 24th line of displayed menu.</p>
13.	<p><b>ARINC 429 BUS Connector (J703)</b></p> <p>Input/Output Connector for ARINC 429 data.</p>
14.	<p><b>RF OUT Connector (J707)</b></p> <p>Output Connector for RF Output signal to MLS Receiver.</p>
15.	<p><b>TEST MENU Display</b></p> <p>7 in Diagonal CRT for data display.</p>
16.	<p><b>REMOTE Indicator</b></p> <p>Illuminates when MLS-800-2 is in Remote (GPIB) Operation.</p>
17.	<p><b>INTENSITY Control</b></p> <p>Controls intensity of TEST MENU Display. Rotation cw increases intensity and rotation ccw decreases intensity.</p> <p><b>CAUTION: DO NOT OPERATE TEST MENU DISPLAY WITH EXCESSIVE INTENSITY.</b></p>

ITEM	DESCRIPTION
18.	<p><b>750 MHz RF OUTPUT Connector (J102)</b></p> <p>Output Connector for 750 MHz modulated RF Output signal.</p>
19.	<p><b>EXTERNAL REFERENCE INPUT Connector (J104)</b></p> <p>Input Connector; external 10 MHz (<math>\pm 60</math> Hz) reference signal to connecting source generation circuit.</p>
20.	<p><b>800 MHz VCO <math>\pm 4</math> OUTPUT Connector (J103)</b></p> <p>Output Connector for 800 MHz VCO <math>\pm 4</math> Output signal.</p>
21.	<p><b>GPIB Connector</b></p> <p>24-Pin Female Connector conforming to IEEE-488-1978 for interface of general purpose programmable instrumentation.</p>
22.	<p><b>DC Fuse</b></p> <p>7.5 A, 32 V minimum, Type F</p>
23.	<p><b>DC POWER Connector</b></p> <p>Input Connector for 11 to 30 Vdc power source.</p>
24.	<p><b>AC POWER Connector</b></p> <p>Input Connector for 103.5 to 240 VAC at 45 to 440 Hz power source.</p>
25.	<p><b>AC LINE Fuse</b></p> <p>2.5 A, 250 V, Type F</p>



THIS PAGE INTENTIONALLY LEFT BLANK.



### 3. MENU DEFINITION

#### 3.1 POWER UP SELF TEST MENU (1-2-3, Figure 4)

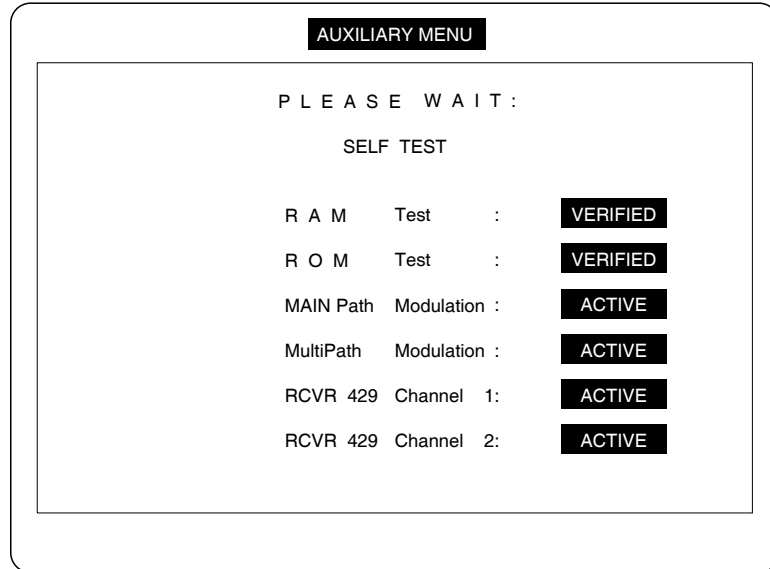

4810001

Power Up Self Test Menu  
Figure 4

ITEM	DESCRIPTION
1.	RAM Test Displays VERIFIED or FAILED.
2.	ROM Test Displays VERIFIED or FAILED.
3.	MAIN Path Modulation Displays ACTIVE or INACTIVE.
4.	MultiPath Modulation Displays ACTIVE or INACTIVE.
5.	RCVR 429 Channel 1 Displays ACTIVE or INACTIVE.
6.	RCVR 429 Channel 2 Displays ACTIVE or INACTIVE.

### 3.2 MASTER MENU (1-2-3, Figure 5)

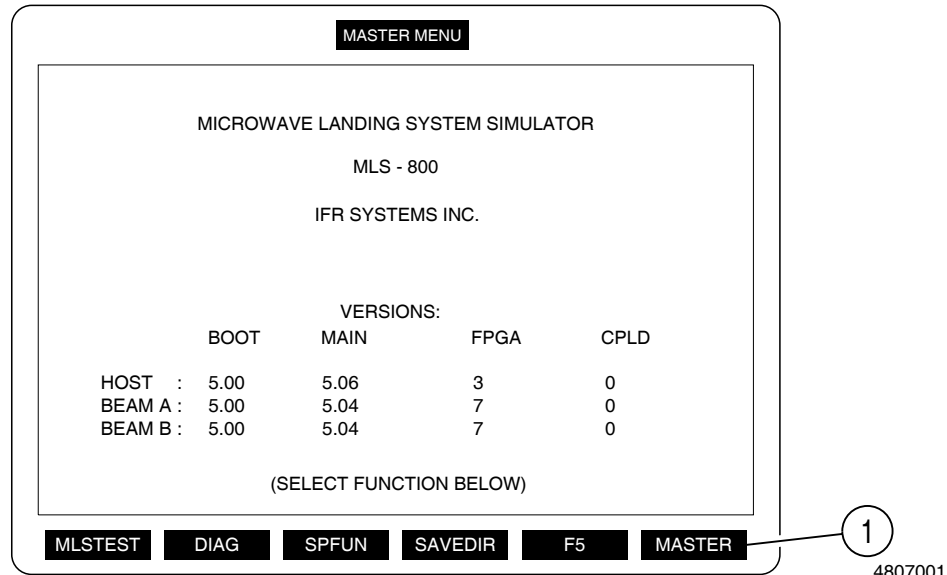

Master Menu  
Figure 5

ITEM	DESCRIPTION
1.	Special Function Key Label Field
	<b>MLSTEST</b> Displays Test Operational Menu.
	<b>DIAG</b> Displays Diagnostic Menu.
	<b>SPFUN</b> Displays Special Function Menu.
	<b>SAVEDIR</b> Displays Save Page Directory Menu.
	<b>F5</b> Not Used.
	<b>MASTER</b> Displays Master Menu

### 3.3 SAVE PAGE DIRECTORY MENU (1-2-3, Figure 6)

Displays current state of the 12 available storage pages in MLS-800-2 Non-Volatile Memory.

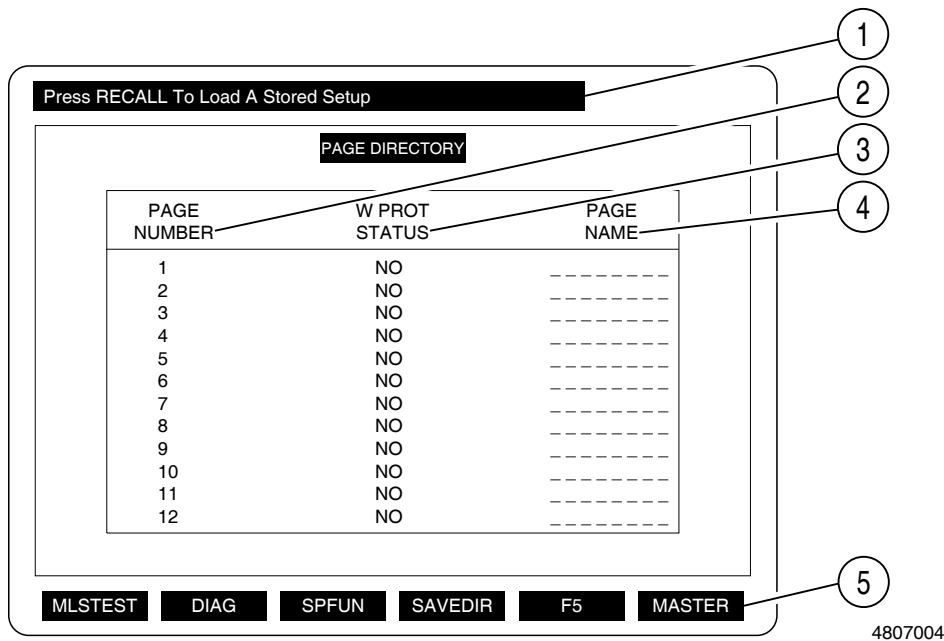

Save Page Directory Menu  
Figure 6

4807004

ITEM	DESCRIPTION	ITEM	DESCRIPTION
1.	Prompt Line Displays instructions for Save Page Directory Menu.	5.	Special Function Key Label Field
2.	Page Number Displays 12 storage pages.	<b>MLSTEST</b> Displays Test Operational Menu.	
3.	W PROT Status Displays condition of Write Protect for each storage page.	<b>DIAG</b> Displays Diagnostic Menu.	
4.	Page Name Displays operator selected name given to menu in storage page. (Refer to para 1-2-5.1.3 for writing name.) <b>NOTE:</b> Dashes indicate inactive or inapplicable data field	<b>SPFUN</b> Displays Special Function Menu.	
		<b>SAVEDIR</b> Displays Save Page Directory Menu.	
		<b>F5</b> Not Used.	
		<b>MASTER</b> Displays Master Menu.	

### 3.4 TEST OPERATIONAL MENU (1-2-3, Figure 7)

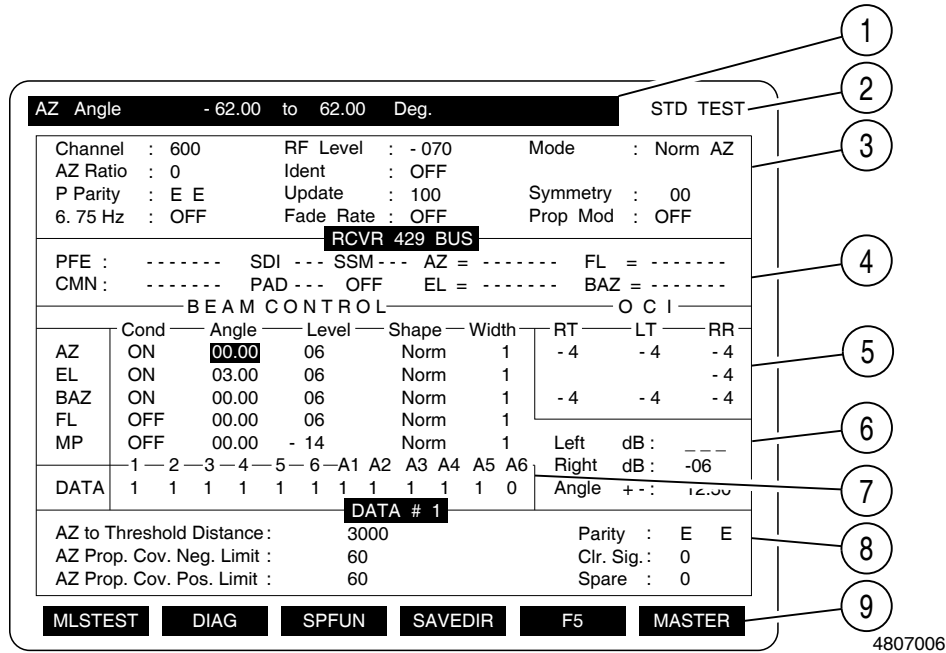

Test Operational Menu  
Figure 7

ITEM	DESCRIPTION	ITEM	DESCRIPTION
1.	<p>Prompt Line</p> <p>Displays Warning Messages and instructions for programming each data field within Test Operational Menu. Prompt Line displays information to Save, Purge and Recall test menus from 12 available storage pages in MLS-800-2 Non-Volatile Memory.</p>	3.	<p>Transmission Characteristics Field (cont)</p> <p><b>Mode</b></p> <p>Displays selected primary mode of operation as Norm AZ (Normal AZ) or High AZ (High Rate AZ).</p> <p><b>AZ Ratio</b></p> <p>Displays status of AZ to EL Ratio (a 75 dB pad is inserted) as 0 or -75 (dB).</p> <p><b>Ident</b></p> <p>Displays Ident Code (Morse Code Identification Sequence) as ON (active), OFF (inactive) or Cont (continuous).</p> <p><b>Sync Flag</b></p> <p>Displays condition of sync.</p> <p>If sync is not active, field is blank.</p>
2.	<p>Menu Label Field</p> <p>Displays 8 character name given to menu for storage in Save Page Directory Menu (1-2-3, Figure 6).</p>		
3.	<p>Transmission Characteristics Field</p> <p><b>Channel</b></p> <p>Displays MLS Channel as 500 to 699.</p> <p><b>RF Level</b></p> <p>Displays RF Output Level as -122 to -017 (dBm).</p>		

ITEM	DESCRIPTION	ITEM	DESCRIPTION
3.	Transmission Characteristics Field (cont)	3.	Transmission Characteristics Field (cont)
	<b>P Parity</b>		<b>Prop Mod</b>
	Displays O O, O E, E O or E E for selected even or odd preamble parity bits on beam when Sync signal is applied.		Displays the propeller or rotor modulation simulation as 001 to 199 (Hz) in 1 Hz steps or OFF.
	<b>Update</b>		<b>NOTE:</b> Only one of three functions (6.75 Hz, Fade Rate or Prop Mod) can operate at any one time.
	Displays variable update rate for Sync Beam as 0, 25, 45, 55, 75 or 100 (%).		When one function is switched ON, the other functions are automatically switched OFF.
	<b>Symmetry</b>	4.	RCVR 429 Received Data Field
	Displays Sync Beam pair offset to produce variation from receiver time reference code for receiver testing at -60 to 60 ( $\mu$ s) in 1 $\mu$ s steps.		RF data beam from MLS-800-2 to MLS Receiver (UUT) is interpreted, returned via ARINC 429 BUS Connector and shown on TEST MENU Display. Returned data displayed on TEST MENU Display is $\pm 62.00$ (degrees) for AZ, -01.50 to 29.50 (degrees) for EL, $\pm 42.00$ (degrees) for BAZ and -02.00 to 10.00 (degrees) for FL.
	<b>6.75 Hz</b>		<b>PFE</b>
	Displays condition of Signal Level Variation Test as ON or OFF.		Displays Path Following Error (PFE), in degrees, for AZ, EL, BAZ or FL, according to Filter Configuration for PFE (Appendix D). PFE displayed depends on Sync function selected in Beam Control Field. PFE is dashed when error is $>1^\circ$ or $<-1^\circ$ .
	<b>NOTE:</b> Only one of three functions (6.75 Hz, Fade Rate or Prop Mod) can operate at any one time.		<b>CMN</b>
	When one function is switched ON, the other functions are automatically switched OFF.		Displays Control Motion Noise (CMN), in degrees, for AZ, EL, BAZ or FL, according to Filter Configuration for CMN (Appendix D). CMN displayed depends on Sync function selected in Beam Control Field. CMN is dashed when error is $>1^\circ$ .
	<b>Fade Rate</b>		<b>SDI</b>
	Displays 1000 (Hz), 1 (Hz), 0.05 (Hz) or OFF for simulation of ground reflections causing modulation level to oscillate.		Displays condition of ARINC 429 Data Bits 9 and 10 as 0 or 1 for Source Designation Identifier (SDI) of function in Sync. (Refer to Receiver Manufacturer's Manual for Bit Definition.)
	<b>NOTE:</b> Only one of three functions (6.75 Hz, Fade Rate or Prop Mod) can operate at any one time.		
	When one function is switched ON, the other functions are automatically switched OFF.		

**ITEM DESCRIPTION**

4. RCVR 429 Received Data Field (cont)
- PAD**  
Displays condition of ARINC 429 Data Bits 11 and 12 as 0 or 1 for Pad of function in Sync. (Refer to Receiver Manufacturer's Manual for Bit Definition.)
- SSM**  
Displays condition of ARINC 429 Data Bits 30 and 31 as 0 or 1 for Sign Status Matrix (SSM) of function in Sync. (Refer to Receiver Manufacturer's Manual for Bit Definition.)
- OFF**  
Displays OFF when no data is received. When data is received, field is blank or displays following Receive Error Messages:
- PE**  
Parity Error in 429 Data.
- OE**  
Overrun Error indicates 429 Data is sent at a higher rate than MLS Receiver can accept.
- WE**  
Word Error for Data not received correctly.

5. Out of Coverage Indicator (OCI) Field
- OCI Right (RT), Left (LT) and Rear (RR) is displayed in dB for AZ, EL or BAZ, when one is selected. Level of simulated signal transmitted is -4 to 7 (dB) relative to preamble.
- RT**  
Displays Right OCI Level from -4 to 7 (dB) relative to preamble level for AZ or BAZ.
- LT**  
Displays Left OCI Level from -4 to 7 (dB) relative to preamble level for AZ or BAZ.
- RR**  
Displays Rear OCI Level from -4 to 7 (dB) relative to preamble level for AZ, EL or BAZ.

**ITEM DESCRIPTION**

6. Beam Control Field
- Allows control of individual beam functions. Switch Condition (Cond), Beam Angle, Beam Modulation Level, Beam Shape and Beam Width are displayed for AZ, EL, BAZ, FL or MP Beams.
- AZ, EL, BAZ and FL are selected for editing by FUNCTION SELECT Keys with Sync. MP is selected for editing by FUNCTION SELECT Keys without Sync.
- Switch Condition**  
Displays operating status as ON or OFF for AZ, EL, BAZ, FL and MP.
- Angle**  
Displays Beam Angle in 0.05° increments:

MODE	RANGE	WIDTH
AZ	-61.00° to 61.00°	0.5
AZ	-61.95° to 61.95°	1.0
AZ	-62.00° to 62.00°	1.5 to 5.0
EL	-01.00° to 29.50°	0.5
EL	-01.50° to 29.50°	1.0 to 5.0
BAZ	-42.00° to 42.00°	0.5
BAZ	-41.75° to 41.75°	1.0 to 5.0
FL	-01.00° to 09.00°	0.5
FL	-02.00° to 10.00°	1.0 to 5.0
MP	-62.00° to 62.00°	0.5 to 5.0

- Level**  
Displays Beam Modulation Level relative to function preamble level:

MODE	LEVEL
AZ	-03 to 13 dB
EL	-03 to 13 dB
BAZ	-03 to 13 dB
FL	-03 to 13 dB
MP	-14 to 13 dB

ITEM	DESCRIPTION
------	-------------

6. Beam Control Field (cont)

**Shape**

Displays Beam Shape as Norm or Half for AZ, EL, BAZ and FL.

Displays Beam Shape as Norm, Half or Clear for MP.

**NOTE:** When Beam Shape is switched to Clear, Beam Control Field changes, allowing control of MP Left and Right Clearance Beam Levels and their common angle.

**NOTE:** Half appears as Normal Pulse for angles at midpoint.

**Width**

Displays Beam Width as 0.5, 1, 2, 3, 4 or 5 (degrees) for AZ, EL, BAZ, FL and MP.

**Left dB**

Displays -03 to 13 (dB). Represents Left Clearance Beam Level relative to preamble level.

**Right dB**

Displays -03 to 13 (dB). Represents Right Clearance Beam Level relative to preamble level.

**Angle**

Displays Clearance Beam Pair Offset from center:

MODE	LEVEL
AZ	±01.00° to ±61.00°
HiAZ	±01.00° to ±41.00°
EL	N/A
BAZ	±01.00° to ±41.00°
FL	N/A

7. Data Word ON/OFF Switches

Displays 1 (ON) or 0 (OFF) for each Data Word.

8. Data Word Field

Six defined Data Words perform designated functions and six Auxiliary Data Words are provided for private use.

### 3.4.1 Data Word #1

DATA # 1		
AZ to Threshold Distance :	3000	Parity : E E
AZ Prop. Cov. Neg. Limit :	60	Clr. Sig. : 0
AZ Prop. Cov. Pos. Limit :	60	Spare : 0

4810021

ITEM	DESCRIPTION
------	-------------

**AZ to Threshold Distance**

Displays 0000 to 6300 (meters) in 100 meter increments.

Represents distance measured parallel to runway center line from approach AZ antenna to runway landing threshold.

**Parity**

Displays O O, O E, E O or E E.

**AZ Prop. Cov. Neg. Limit**

Displays 00 to -62 (degrees) in 2° increments.

Represents limit of sector in which proportional approach AZ guidance is transmitted.

**Clr. Sig.**

Displays 0 for Pulse or 1 for Scanning Clearance.

Indicates method of providing AZ Clearance Signal.

**AZ Prop. Cov. Pos. Limit**

Displays 00 to 62 (degrees) in 2° increments.

Represents limit of sector in which proportional approach AZ guidance is transmitted.

**Spare**

Displays 0 or 1 for 1 Binary Field.



### 3.4.2 Data Word #2

DATA # 2		
Min. Glide Path : 03.0	BAZ Status : 1	Parity: E E
DME Status : 0 0	AZ Status : 1	
EL Status : 1	Spare : 0 0 0 0 0	

4810012

ITEM	DESCRIPTION
<p><b>Min Glide Path</b></p> <p>Displays 02.0 to 14.7 (degrees) in 1.0° increments.</p> <p>Represents lowest angle of descent along 0° AZ consistent with published approach procedures and obstacle clearance criteria.</p> <p><b>BAZ Status</b></p> <p>Displays 0 (Not Radiated) or 1 (Radiated in Normal Mode).</p> <p>Represents operational status of BAZ equipment.</p> <p><b>Parity</b></p> <p>Displays O O, O E, E O or E E.</p> <p><b>DME Status</b></p> <p>Displays 0 0 for DME Transponder inoperative, 1 0 for Only IA Mode or DME/N available, 0 1 for FA Mode - Standard 1 available or 1 1 for FA Mode - Standard 2 available.</p> <p>Represents operational status of DME equipment.</p> <p><b>AZ Status</b></p> <p>Displays 0 (Not Radiated) or 1 (Radiated in Normal Mode).</p> <p>Represents operational status of approach AZ equipment.</p> <p><b>EL Status</b></p> <p>Displays 0 (Not Radiated) or 1 (Radiated in Normal Mode).</p> <p>Represents operational status of approach EL equipment.</p>	<p><b>Spare</b></p> <p>Displays 0 or 1 for 6 Binary Fields.</p>

### 3.4.3 Data Word #3

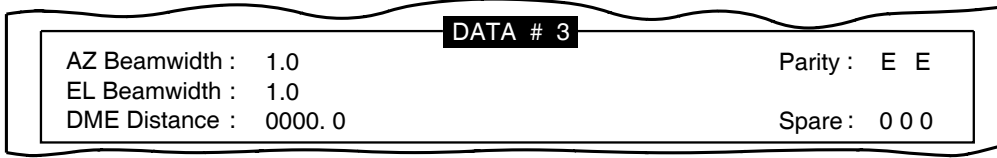

4810011

ITEM	DESCRIPTION
------	-------------

**AZ Beamwidth**

Displays 0.5 to 4.0 (degrees) in 0.5° increments.

Represents width of scanning beam main lobe measured at -3 dB points and defined in angular units on antenna bore sight in horizontal plane.

**Parity**

Displays O O, O E, E O or E E.

**EL Beamwidth**

Displays 0.5 to 2.5 (degrees) in 0.5° increments.

Represents width of scanning beam main lobe measured at -3 dB points and defined in angular units on antenna bore sight in vertical plane.

**DME Distance**

Displays 0000.0 to 6387.5 (meters) in 12.5 meter increments.

Represents distance measured parallel to runway center line from DME antenna phase center to MLS datum point.

**Spare**

Displays 0 or 1 for 3 Binary Fields.

3.4.4 Data Word #4

DATA # 4		
AZ Zero-Degree Guidance Plane	: 000	Parity: E E
BAZ Zero-Degree Guidance Plane	: 000	

4810013

ITEM	DESCRIPTION
	<p><b>AZ Zero-Degree Guidance Plane</b></p> <p>Displays 000 to 359 (degrees) in 1° increments.</p> <p>Represents angle measured in horizontal plane cw from Magnetic North to 0° angle guidance plane of approach AZ antenna. Vertex of measured angle is approach AZ antenna phase center.</p> <p><b>Parity</b></p> <p>Displays O O, O E, E O or E E.</p> <p><b>BAZ Zero-Degree Guidance Plane</b></p> <p>Displays 000 to 359 (degrees) in 1° increments.</p> <p>Represents angle measured in horizontal plane cw from Magnetic North to 0° angle guidance plane of BAZ antenna.</p>

3.4.5 Data Word #5

DATA # 5	
BAZ Prop. Cov. Neg. : 42	Parity : E E
BAZ Prop. Cov. Pos. : 42	BAZ Status : 0
BAZ Beamwidth : 1.0	Spare : 0 0 0 0

4810014

ITEM	DESCRIPTION
------	-------------

**BAZ Prop. Cov. Neg.**

Displays 00 to -42 (degrees) in 2° increments.

Represents limit of sector in which proportional BAZ guidance is transmitted.

**Parity**

Displays O O, O E, E O or E E.

**BAZ Prop. Cov. Pos.**

Displays 00 to 42 (degrees) in 2° increments.

Represents limit of sector in which proportional BAZ guidance is transmitted.

**BAZ Status**

Displays 0 (Not Radiated) or 1 (Radiated in Normal Mode).

Represents operational status of BAZ equipment.

**BAZ Beamwidth**

Displays 0.5 to 4.0 (degrees) in 0.5° increments.

Represents actual width of scanning beam main lobe measured at -3 dB points.

**Spare**

Displays 0 or 1 for 4 Binary Fields.

3.4.6 Data Word #6



4810015

ITEM	DESCRIPTION
<b>Ground Station ID</b>	<p>Adjustable display.</p> <p>Represents ground station identification in three (3) user definable characters determined by the user. Each character is followed by a parity bit.</p>
<b>Parity</b>	<p>Displays O O, O E, E O or E E.</p>

### 3.4.7 Auxiliary Data Word A1

DATA AD1			
Aux Data	: A1	Parity	: E E E E E E E
AZ Ant. Offset	: 000	AZ Ant. Co-ord.	: 0            Ant. Height : 00
AZ Ant. Align.	: 00.00	AZ to MLS Datum	: 0000            Spare : 00

4810016

ITEM	DESCRIPTION
<p><b>Aux Data</b></p> <p>Displays A1.</p> <p><b>Parity</b></p> <p>Displays combinations shown in 1-2-3, Table 1.</p> <p><b>AZ Ant. Offset</b></p> <p>Displays -511 to 511 (meters) in 1 meter increments.</p> <p>Represents minimum distance between approach AZ antenna phase center and vertical plane containing runway center line.</p> <p><b>AZ Ant. Co-ord.</b></p> <p>Displays 0 (Conical) or 1 (Planar).</p> <p>Represents coordinate system of angle data transmitted by approach AZ antenna.</p> <p><b>Ant. Height (AZ)</b></p> <p>Displays -63 to 63 (meters) in 1 meter increments.</p> <p>Represents height of AZ antenna phase center relative to height of MLS datum point.</p> <p><b>AZ Ant. Align.</b></p> <p>Displays -20.47 to 20.47 (degrees) in 0.01° increments.</p> <p>Represents minimum angle between approach AZ antenna 0° guidance plane and runway center line.</p>	<p><b>AZ to MLS Datum</b></p> <p>Displays 0000 to 8191 (meters) in 1 meter increments.</p> <p>Represents minimum distance between approach antenna phase center and vertical plane perpendicular to center line which contains MLS datum point.</p> <p><b>Spare</b></p> <p>Displays 00 to 77 (Octal).</p>

### 3.4.8 Auxiliary Data Word A2

DATA AD2			
Aux Data	: A 2	Parity	: E E E E E E E
EL Antenna Offset	: 0 0 0	EL Ant. Height	: 0. 0      MLS EL : 0000
MLS Datum to Thresh.	: 0 0 0 0	Thresh. Height	: 0. 0      Spare : 0

4810017

ITEM	DESCRIPTION	ITEM	DESCRIPTION
	<p><b>Aux Data</b></p> <p>Displays A2.</p> <p><b>Parity</b></p> <p>Displays combinations shown in 1-2-3, Table 1.</p> <p><b>EL Antenna Offset</b></p> <p>Displays -511 to 511 (meters) in 1 meter increments.</p> <p>Represents minimum distance between EL antenna phase center and vertical plane containing runway center line.</p> <p><b>EL Ant. Height</b></p> <p>Displays -6.3 to 6.3 (meters) in 0.1 meter increments.</p> <p>Represents height of EL antenna phase center relative to height of MLS datum point.</p> <p><b>MLS EL</b></p> <p>Displays -4095 to 4095 (meters) in 1 meter increments.</p> <p>Represents datum point elevation relative to main sea level (msl).</p> <p><b>MLS Datum to Thresh.</b></p> <p>Displays 0000 to 1023 (meters) in 1 meter increments.</p> <p>Represents distance measured along runway center line from MLS datum point to runway threshold.</p>		<p><b>Thresh. Height</b></p> <p>Displays -6.3 to 6.3 (meters) in 0.1 meter increments</p> <p>Represents vertical location of the intersection of the runway threshold and center line with respect to the MLS datum point.</p> <p><b>Spare</b></p> <p>Displays 0 to 3 (Octal).</p>

### 3.4.9 Auxiliary Data Word A3

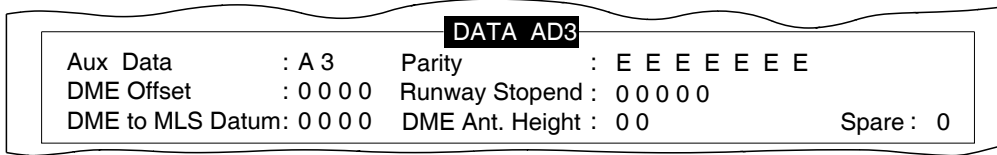

4810018

ITEM	DESCRIPTION
------	-------------

**Aux Data**

Displays A3.

**Parity**

Displays combinations shown in 1-2-3, Table 1.

**DME Offset**

Displays -2047 to 2047 (meters) in 1 meter increments.

Represents minimum distance between DME antenna phase center and vertical plane containing runway center line.

**Runway Stopend**

Displays 00000 to 16383 (meters) in 1 meter increments.

Represents distance to end of runway.

**DME to MLS Datum**

Displays -8191 to 8191 (meters) in 1 meter increments.

Represents minimum distance between DME antenna phase center and vertical plane perpendicular to center line containing MLS datum point.

**DME Ant. Height**

Displays -63 to 63 (meters) in 1 meter increments.

Represents vertical location of the DME antenna phase center with respect to the MLS datum point.

**Spare**

Displays 0 to 3 (Octal).



### 3.4.10 Auxiliary Data Word A4

DATA AD4			
Aux Data	: A 4	Parity	: E E E E E E E
BAZ Ant. Offset	: 0 0 0	BAZ Ant. Co-ord.:	0 Ant. Height: 0 0
BAZ to MLS Datum:	0 0 0 0	BAZ Ant. Align.:	0 0 . 0 0 Spare: 0 0 0

4810019

ITEM	DESCRIPTION
<p><b>Aux Data</b></p> <p>Displays A4.</p> <p><b>Parity</b></p> <p>Displays combinations shown in 1-2-3, Table 1.</p> <p><b>BAZ Ant. Offset</b></p> <p>Displays -511 to 511 (meters) in 1 meter increments.</p> <p>Represents minimum distance between BAZ antenna phase center and vertical plane containing runway center line.</p> <p><b>BAZ Ant. Co-ord.</b></p> <p>Displays 0 for Conical or 1 for Planar.</p> <p>Represents co-ordinate system (planar and conical) of the angle data transmitted by the BAZ antenna.</p> <p><b>Ant. Height</b></p> <p>Displays -63 to 63 (meters) in 1 meter increments.</p> <p>Represents height of antenna relative to the runway.</p> <p><b>BAZ to MLS Datum</b></p> <p>Displays 0000 to 2047 (meters) in 1 meter increments.</p> <p>Represents minimum distance between BAZ antenna phase center and vertical plane perpendicular to center line containing MLS datum point.</p> <p><b>BAZ Ant. Align.</b></p> <p>Displays -20.47 to 20.47 (degrees) in 0.01° increments.</p> <p>Represents minimum angle between BAZ antenna 0° guidance plane and runway center line.</p>	<p><b>Spare</b></p> <p>Displays 000 to 377 (Octal).</p>

3.4.11 Auxiliary Data Word A5

DATA AD5			
Aux Data	: A 5	Parity	: E E E E E E E
RVR (TD zone)	: 0 0 0 0	RVR (midpoint)	: 0 0 0 0
RVR (stopend)	: 0 0 0 0	Surface Wind	: 0 0 0      Wind Dir : 0 0 0

4810080

ITEM	DESCRIPTION
------	-------------

**Aux Data**

Displays A5.

**Parity**

Displays combinations shown in 1-2-3, Table 1.

**RVR (TD zone)**

Displays 0000 to 2555 (meters) in 5 meter increments.

Represents distance of instrument to touchdown zone of runway.

**RVR (midpoint)**

Displays 0000 to 2555 (meters) in 5 meter increments.

Represents distance of instrument to midpoint of runway.

**RVR (stopend)**

Displays 0000 to 2555 (meters) in 5 meter increments.

Represents distance of instrument to stop end of runway.

**Surface Wind**

Displays 000 to 127 (noeuds) in 1 noeud increments.

Represents surface wind speed.

**Wind Dir**

Displays 000 to 359 (degrees) in 1° increments.

Represents surface wind direction.

**NOTE:** Only AD5 or AD6 can be ON at any one time. Both may not be ON at the same time.

### 3.4.12 Auxiliary Data Word A6

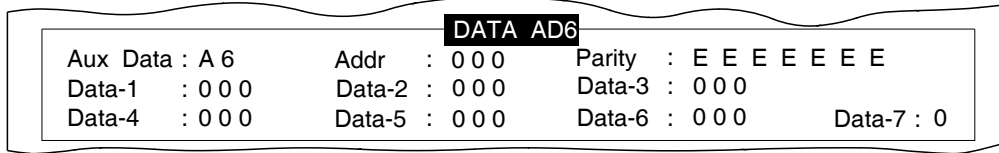

4810081

ITEM	DESCRIPTION	ITEM	DESCRIPTION
<b>Aux Data</b>	Displays A6.	<b>Data-7</b>	Displays 0 or 1.
<b>Addr</b>	Displays 000 to 377. Represents user definable bits.		Represents user definable bits.
<b>Parity</b>	Displays combinations shown in 1-2-3, Table 1.	<b>NOTE:</b>	Only AD5 or AD6 can be ON at any one time. Both may <u>not</u> be ON at the same time.
<b>Data-1</b>	Displays 000 to 377. Represents user definable bits.		
<b>Data-2</b>	Displays 000 to 377. Represents user definable bits.		
<b>Data-3</b>	Displays 000 to 377. Represents user definable bits.		
<b>Data-4</b>	Displays 000 to 377. Represents user definable bits.		
<b>Data-5</b>	Displays 000 to 377. Represents user definable bits.		
<b>Data-6</b>	Displays 000 to 377. Represents user definable bits.		

AUXILIARY DATA WORD PARITY COMBINATIONS			
0000000	0E00000	E000000	EE00000
000000E	0E0000E	E00000E	EE0000E
00000E0	0E000E0	E0000E0	EE000E0
00000EE	0E000EE	E0000EE	EE000EE
0000E00	0E00E00	E000E00	EE00E00
0000E0E	0E00E0E	E000E0E	EE00E0E
0000EEO	0E00EEO	E000EEO	EE00EEO
0000EEE	0E00EEE	E000EEE	EE00EEE
000E000	0E0E000	E00E000	EE0E000
000E00E	0E0E00E	E00E00E	EE0E00E
000E0EO	0E0E0EO	E00E0EO	EE0E0EO
000E0EE	0E0E0EE	E00E0EE	EE0E0EE
000EE00	0E0EE00	E00EE00	EE0EE00
000EE0E	0E0EE0E	E00EE0E	EE0EE0E
000EEEO	0E0EEEO	E00EEEO	EE0EEEO
000EEEE	0E0EEEE	E00EEEE	EE0EEEE
00E0000	0EE0000	E0E0000	EEE0000
00E000E	0EE000E	E0E000E	EEE000E
00E00EO	0EE00EO	E0E00EO	EEE00EO
00E00EE	0EE00EE	E0E00EE	EEE00EE
00E0E00	0EE0E00	E0E0E00	EEE0E00
00E0E0E	0EE0E0E	E0E0E0E	EEE0E0E
00E0EEO	0EE0EEO	E0E0EEO	EEE0EEO
00E0EEE	0EE0EEE	E0E0EEE	EEE0EEE
00EE000	0EEEE00	E0EE000	EEEE000
00EE00E	0EEEE0E	E0EE00E	EEEE00E
00EE0EO	0EEEEEO	E0EE0EO	EEEE0EO
00EE0EE	0EEEEEE	E0EE0EE	EEEE0EE
00EEEO0	0EEEO00	E0EEEO0	EEEO000
00EEEOE	0EEEO0E	E0EEEOE	EEEO00E
00EEEOEO	0EEEOEO	E0EEEOEO	EEEO0EO
00EEEOEE	0EEEOEE	E0EEEOEE	EEEO0EE
00EEEOEO	0EEEOEO	E0EEEOEO	EEEO0EO
00EEEOEEO	0EEEOEEO	E0EEEOEEO	EEEO0EEO
00EEEOEEE	0EEEOEEE	E0EEEOEEE	EEEO0EEE
00EEEE000	0EEEE000	E0EEEE000	EEEE00000
00EEEE00E	0EEEE00E	E0EEEE00E	EEEE0000E
00EEEE0EO	0EEEE0EO	E0EEEE0EO	EEEE000EO
00EEEE0EE	0EEEE0EE	E0EEEE0EE	EEEE000EE
00EEEEEO0	0EEEEEO0	E0EEEEEO0	EEEE00000
00EEEEEOE	0EEEEEOE	E0EEEEEOE	EEEE0000E
00EEEEEOEO	0EEEEEOEO	E0EEEEEOEO	EEEE0000EO
00EEEEEOEE	0EEEEEOEE	E0EEEEEOEE	EEEE0000EE
00EEEEEOEO	0EEEEEOEO	E0EEEEEOEO	EEEE0000EO
00EEEEEOEEO	0EEEEEOEEO	E0EEEEEOEEO	EEEE0000EEO
00EEEEEOEEE	0EEEEEOEEE	E0EEEEEOEEE	EEEE0000EEE

Auxiliary Data Word Parity Combinations  
Table 1

ITEM	DESCRIPTION
9. Special Function Key Label Field	
	<b>MLSTEST</b>
	Displays Test Operational Menu.
	<b>DIAG</b>
	Displays Diagnostic Menu.
	<b>SPFUN</b>
	Displays Special Function Menu.
	<b>SAVEDIR</b>
	Displays Save Test Menu Directory.
	<b>F5</b>
	Not Used.
	<b>MASTER</b>
	Displays Master Menu.

### 3.5 DIAGNOSTIC MENU (1-2-3, Figure 8)

The Diagnostic Menu allows the operator to set conditions for and run desired tests on the MLS-800-2.

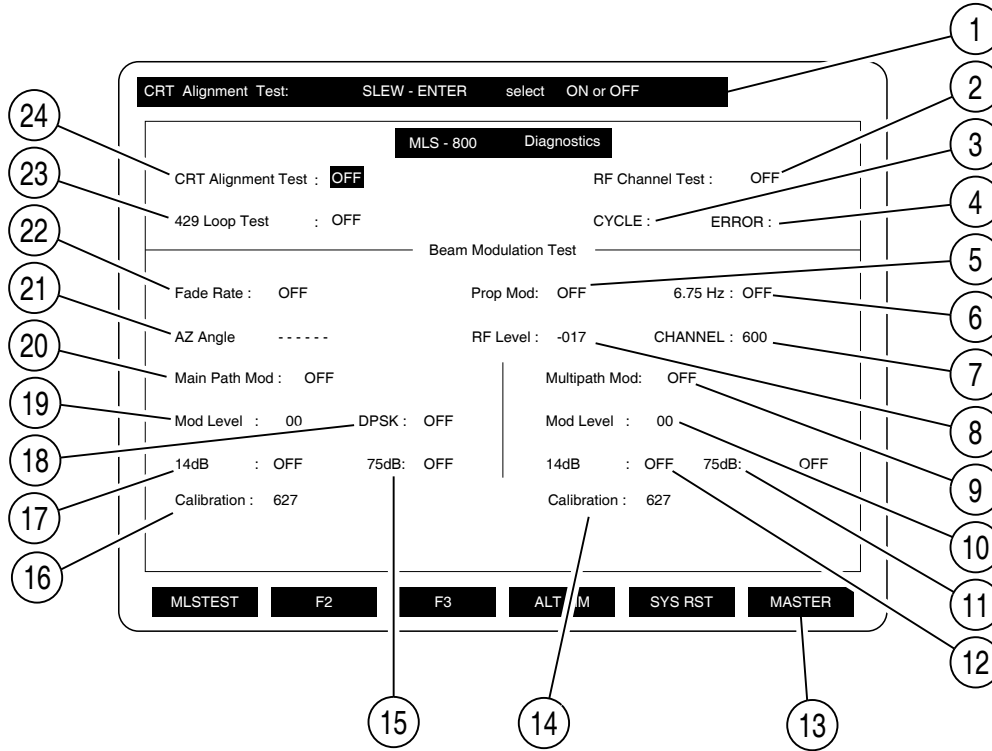

4807003

Diagnostic Menu  
Figure 8

ITEM	DESCRIPTION	ITEM	DESCRIPTION
1.	Prompt Line Displays instructions for programming each field within Diagnostic Menu.	5.	Prop Mod Displays propeller or rotor modulation simulation as 000 to 199 (Hz) in 1 Hz steps or OFF. (Applied to Main Path Modulation only.)
2.	RF Channel Test Refer to para 1-2-5.3.3.	6.	6.75 Hz Displays condition of Signal Level Variation Test as ON or OFF. (Applied to Main Path Modulation only.)
3.	CYCLE Displays cycle count for 429 Loop Test in progress (Display Only).	7.	Channel Displays MLS-800-2 Channel as 500 to 699. (Active on Main Path and Multipath Modulation tests only.)
4.	ERROR Displays error count for 429 Loop Test in progress (Display Only).		

ITEM	DESCRIPTION	ITEM	DESCRIPTION
8.	<p><b>RF Level</b></p> <p>Displays RF Output Level as -122 to -017 (dBm) to set RF Levels during CW test for accurate measurements.</p>	11.	<p><b>Multipath 75 dB</b></p> <p>Displays 75 dB Pad condition as ON or OFF. Cycles 75 dB Pad, normally used to disable (OFF) a function (and in case of Main Path Beam, for 75 dB AZ Ratio test), during CW test for accurate measurements. (Not active for AZ or OFF Beam Modulation). Attenuates combined Main Path and Multipath signals or Multipath signal only.</p>
9.	<p><b>Multipath Mod</b></p> <p>Displays Multipath Modulation Function as follows:</p> <p><b>OFF</b></p> <p>Beam Modulation Output is 0 V. The 75 and 14 dB Pads are enabled.</p> <p><b>0 VOLTS</b></p> <p>Beam Modulation Output is 0 V.</p> <p><b>CW</b></p> <p>Outputs continuous Preamble signal from Beam Modulation Synthesizer.</p> <p><b>+60 AZ</b></p> <p>Normal AZ signal at +60° with SYNC ON AZ enabled to verify TO/FRO pulse operation.</p> <p><b>-60 AZ</b></p> <p>Normal AZ signal at -60° with SYNC ON AZ enabled to verify TO/FRO pulse operation.</p> <p><b>0 AZ</b></p> <p>Normal AZ signal at 0° with SYNC ON AZ enabled to verify TO/FRO pulse operation.</p> <p><b>1000 TRI</b></p> <p>1000 Hz triangular wave at -20 to +15 dB from Beam Modulation Synthesizer to verify modulation linearity.</p>	12.	<p><b>Multipath 14 dB</b></p> <p>Displays 14 dB Pad condition as ON or OFF. Cycles 14 dB Pad, normally used to attenuate beam side lobes, during CW test for accurate measurements. (Not active for AZ or OFF Beam Modulation.)</p>
10.	<p><b>Multipath Mod Level</b></p> <p>Displays Multipath Beam Modulation Level as -20 to +15 (dB).</p>	13.	<p><b>Special Function Key Label Field</b></p> <p><b>MLSTEST</b></p> <p>Displays Test Operational Menu.</p> <p><b>F2</b></p> <p>Not Used.</p> <p><b>F3</b></p> <p>Not Used.</p> <p><b>ALT MM</b></p> <p>Swaps preset test conditions (Beam Mod, Mod Level, 14 dB Pad) between the Main Path and Multipath modulations.</p> <p><b>SYS RST</b></p> <p>Resets system to Power-Up state.</p> <p><b>MASTER</b></p> <p>Displays Master Menu.</p>
		14.	<p><b>Calibration</b></p> <p>Displays corresponding calibration values for the Multipath Modulation Level entered. Values range from 0 to 4095. SoftCal values can only be modified by removing the cover and sending a RS-232 command to the unit. (Contact Aeroflex Customer Service Department for assistance.)</p>

ITEM	DESCRIPTION	ITEM	DESCRIPTION
15.	<p>Main Path 75 dB</p> <p>Displays 75 dB Pad condition as ON or OFF. Cycles 75 dB Pad, normally used to disable (OFF) a function (and in case of Main Path Beam, for 75 dB AZ Ratio test), during CW test for accurate measurements. (<u>Not active</u> for AZ or OFF Beam Modulation.) Attenuates combined Main Path and Multipath signals or Multipath signal only.</p>	20.	<p>Main Path Mod (cont)</p> <p><b>CW</b></p> <p>Outputs continuous Preamble signal from Beam Modulation Synthesizer.</p> <p><b>+60 AZ</b></p> <p>Normal AZ signal at +60° with SYNC ON AZ enabled. Used to verify TO/FRO pulse operation.</p> <p><b>-60 AZ</b></p> <p>Normal AZ signal at -60° with SYNC ON AZ enabled to verify TO/FRO pulse operation.</p> <p><b>0 AZ</b></p> <p>Normal AZ signal at 0° with SYNC ON AZ enabled to verify TO/FRO pulse operation.</p> <p><b>1000 TRI</b></p> <p>1000 Hz triangular wave at -20 to +15 dB from Beam Modulation Synthesizer to verify modulation linearity.</p>
16.	<p>Calibration</p> <p>Displays corresponding calibration values for the Main Path Modulation Level entered. Values range from 0 to 4095. SoftCal values can only be modified by removing the cover and sending a RS-232 command to the unit. (Contact Aeroflex Customer Service Department for assistance.)</p>	21.	<p>AZ Angle</p> <p>Displays Azimuth angle <math>\pm 0.1^\circ</math> when modulation level is +6 to +13 dB (Display only). (Active on Main Path Modulation test only.)</p>
17.	<p>Main Path 14 dB</p> <p>Displays 14 dB Pad condition as ON or OFF. Cycles 14 dB Pad, normally used to attenuate beam side lobes, during CW test for accurate measurements. (<u>Not active</u> for AZ or OFF Beam Modulation.)</p>	22.	<p>Fade Rate</p> <p>Displays 1000 (Hz), 1 (Hz), 0.05 (Hz) or OFF for simulation of ground reflections causing modulation level to oscillate. (Applied to Multipath Modulation only.)</p>
18.	<p>Main Path DPSK</p> <p>Displays DPSK condition as ON, OFF or Cont. Cycles DPSK level during CW test for accurate measurements of 180° phase shift requirement for transmitting digital data. DPSK is cycled at a continuous 15.625 kHz rate, which is specified MLS data rate. (<u>Not active</u> for Main Path AZ or OFF Beam Modulation.)</p>	23.	<p>429 Loop Test</p> <p>Refer to para 1-2-5.3.4.</p>
19.	<p>Main Path Mod Level</p> <p>Displays Main Path Beam Modulation Level as -20 to +15 (dB).</p>	24.	<p>CRT Alignment Test</p> <p>Refer to para 1-2-5.3.2.</p>
20.	<p>Main Path Mod</p> <p>Displays Main Path Modulation Function as follows:</p> <p><b>OFF</b></p> <p>Beam Modulation Output is 0 V. The 75 and 14 dB Pads are enabled.</p> <p><b>0 VOLTS</b></p> <p>Beam Modulation Output is 0 V.</p>		



### 3.6 SPECIAL FUNCTION MENU (1-2-3, Figure 9)

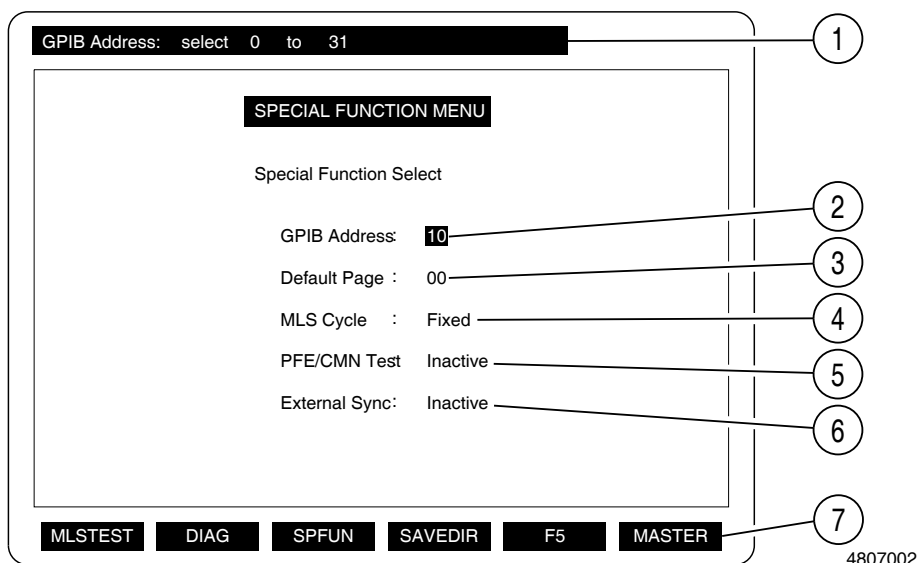

Special Function Menu  
Figure 9

ITEM	DESCRIPTION	ITEM	DESCRIPTION
1.	<b>Prompt Line</b> Instructional tract for programming each field within Special Function Menu.	5.	<b>PFE/CMN Test</b> Displays PFE/CMN Test as Active or Inactive. When Active, displays maximum value for PFE and 95% value for CMN every 10 or 40 sec when Multipath is active. Values are displayed in PFE and CMN data fields in reverse video to distinguish from PFE and CMN data.
2.	<b>GPIB Address</b> Displays optional GPIB Address as 00 to 31. GPIB Address is stored in Non-Volatile Memory.	6.	<b>External Sync</b> Displays Active or Inactive. When Active, MLS-800-2 can be synced with another MLS-800-2.
3.	<b>Default Page</b> Displays number of page (00 to 12) from Save Directory to be recalled on power up. If page is 00 or no page is stored at memory address, standard test condition for ICAO 1985 is default page and Master Menu is displayed as a default menu.	7.	<b>Special Function Key Label Field</b> <b>MLSTEST</b> Displays Test Operational Menu. <b>DIAG</b> Displays Diagnostic Menu. <b>SPFUN</b> Displays Special Function Menu. <b>SAVEDIR</b> Displays Save Page Directory Menu.
4.	<b>MLS Cycle</b> Displays cycle time as Fixed or Variable. When Variable, cycle time varies 5 ms randomly to avoid interference problems. Cycle length is fixed during Diagnostics operation.		



ITEM	DESCRIPTION
7. Special Function Key Label Field (cont)	
	<b>F5</b>
	Not Used.
	<b>MASTER</b>
	Displays Master Menu.

## 4. PERFORMANCE EVALUATION

### 4.1 GENERAL

The MLS-800-2 is equipped with a Power Up Self Test for testing the condition of the RAM, ROM, Main Path, Multipath, RCVR Channel 1 and RCVR Channel 2.

The MLS-800-2 contains three Diagnostic Tests (para 1-2-5.3) for additional testing and evaluation.

**NOTE:** The 50  $\Omega$  Loads must be connected to the 750 MHz RF OUTPUT Connector and 800 MHz VCO  $\div$  4 OUTPUT Connector when performing the Power Up Self Test or Diagnostic Tests.

### 4.2 POWER UP SELF TEST

STEP	PROCEDURE
1.	Set PWR/OFF/BATT Switch to PWR. Verify POWER Indicator is illuminated.
2.	Verify Power Up Self Test Menu appears.
3.	Verify RAM Test displays <b>VERIFIED</b> .  If RAM Test displays <b>FAILED</b> , contact Aeroflex Customer Service Department for further testing and maintenance instructions.
4.	Verify ROM Test displays <b>VERIFIED</b> .  If ROM Test displays <b>FAILED</b> , contact Aeroflex Customer Service Department for further testing and maintenance instructions.
5.	Verify Main Path Modulation displays <b>ACTIVE</b> .  If Main Path Modulation displays <b>INACTIVE</b> , contact Aeroflex Customer Service Department for further testing and maintenance instructions.
6.	Verify Multipath Modulation displays <b>ACTIVE</b> .  If Multipath Modulation displays <b>INACTIVE</b> , contact Aeroflex Customer Service Department for further testing and maintenance instructions.
7.	Verify RCVR 429 Channel 1 displays <b>ACTIVE</b> .  If RCVR 429 Channel 1 displays <b>INACTIVE</b> , contact Aeroflex Customer Service Department for further testing and maintenance instructions.
8.	Verify RCVR 429 Channel 2 displays <b>ACTIVE</b> .  If RCVR 429 Channel 2 displays <b>INACTIVE</b> , contact Aeroflex Customer Service Department for further testing and maintenance instructions.



THIS PAGE INTENTIONALLY LEFT BLANK.

## 5. OPERATING PROCEDURES

### 5.1 KEYBOARD OPERATING PROCEDURES

Using the MLS-800-2 Keyboard, the operator can display, store, retrieve, erase and automatically execute test data according to the Keyboard operating requirements.

#### 5.1.1 DATA ENTRY and DATA SLEW Keys

STEP	PROCEDURE
------	-----------

Change data value or status within data field by use of DATA ENTRY Keys or DATA SLEW Keys in conjunction with CURSOR Keys.

**NOTE:** Cursor is displayed as blinking reverse video. Data field cursor is pointing towards is displayed as non-blinking reverse video.

To change the data value or status with the DATA ENTRY Keys, position cursor directly over data field and use DATA ENTRY Keys to change value or status. Press ENTER Key.

To change the data value or selection with the DATA SLEW Keys, position cursor directly over data field and use DATA SLEW Keys to change value or selection. Press ↑ DATA SLEW Keys to increase value or change selection. Press ↓ DATA SLEW Keys to decrease value or change selection. Press FAST DATA SLEW Keys for most significant half of data field to increase or decrease. Press SLOW DATA SLEW Keys for least significant half of data field to increase or decrease.

### 5.1.2 Recall Data Page

STEP	PROCEDURE
------	-----------

1. Press RECALL on STORED DATA Keys. Prompt Line RECALL: Select page number 1 to 12; press ENTER appears.
2. Press number keys for desired storage page number (1 through 12) and ENTER Key.

**NOTE:** If desired Recall page is empty, Prompt Line Page # is empty flashes on and off four times, then returns to previous Prompt Line.

**NOTE:** Recall projects a copy of the Test Operational Menu from the storage pages. The Test Operational Menu remains in the storage pages until overwritten or purged.

### 5.1.3 Save Data Page

STEP	PROCEDURE
------	-----------

1. Press SAVE on STORED DATA Keys. Prompt Line SAVE: Select page number 1 to 12; press ENTER appears.
2. Press number keys for desired storage page number (1 through 12) and ENTER Key. Prompt Line Slew in the name and ENTER; press ESC to ignore name appears.
3. Use DATA SLEW Keys to enter name for storage page. Name is selected character by character for a maximum of eight characters. Choice of character is: A through Z, 0 through 9, -, # or Blank Space. When desired character is displayed, move cursor to next character.
4. Press ENTER Key. Prompt Line Write Protect Required: Yes="W PROT" No="ENTER" appears.
5. Press W PROT on DATA CONTROL Keys to write protect storage page or ENTER Key to disregard write protect on storage page.

**NOTE:** If desired Save page location is full, Prompt Line Page # is full, press ENTER if overwrite is desired appears.

**NOTE:** If desired Save page location is Write Protected, Prompt Line Cannot save; Page # is Write Protected flashes ON and OFF four times, then returns to previous Prompt Line.

### 5.1.4 Purge Data Page

STEP	PROCEDURE
------	-----------

1. Press PURGE on STORED DATA Keys. Prompt Line PURGE: Select page number 1 to 12; press ENTER appears.
2. Press number keys for desired storage page number (1 through 12) and ENTER Key.

**NOTE:** PURGE erases the Test Operational Menu in memory, not the Test Operational Menu on the TEST MENU Display. Switching to another menu, deletes the Test Operational Menu on the TEST MENU Display.

### 5.1.5 Write Protect Data Page

STEP	PROCEDURE
------	-----------

---

1. Press W PROT on DATA CONTROL Keys. Prompt Line W PROT: Select page number 1 to 12; press ENTER appears.
2. Press number keys for desired storage page number (1 through 12) and ENTER Key.

**NOTE:** When a storage page is write protected, the Save Page Directory Menu displays YES in the W PROT STATUS column for the storage page.

### 5.1.6 Delete Data Page

STEP	PROCEDURE
------	-----------

---

Acts as a backspace key, going from right (least significant digit) to left (most significant digit).

Changes all command numbers to 0 and negative value (-) to positive value (+) when deleting entire command.

**NOTE:** When a setting is deleted, the ENTER Key must be pressed before the cursor is free to move to other fields.

### 5.1.7 SYNC Function

STEP	PROCEDURE
------	-----------

The SYNC Key toggles ON/OFF to activate/deactivate the Sync function. Sync is active on assigned beam until Sync is deactivated. Sync is active on only one function at any one time.

When Sync is active, a Sync Flag (para 1-2-3.3.4) is displayed in the Transmission Characteristics field of the Test Operational Menu.

Corresponding Sync Beam Functions (Symmetry, P Parity, Update, PAD, SDI, SSM, PFE, CMN and MP) operate only when Sync is active and appear in reverse video if active. Corresponding Sync Beam Functions operate on AZ, EL, FL, BAZ and all DATA Word transmissions. When Sync is deactivated, Corresponding Sync Beam Functions (internally active) change from reverse video to normal video and the Corresponding Sync Beam Functions are disabled.

Refer to 1-2-5, Table 2 for keystrokes required to enable Sync on available functions.

FUNCTION	KEYSTROKES	FUNCTION	KEYSTROKES
AZ	SYNC AZ	DATA 5	SYNC DATA 5
EL	SYNC EL	DATA 6	SYNC DATA 6
BAZ	SYNC BAZ	DATA AD1	SYNC AUX 1
FL	SYNC FL	DATA AD2	SYNC AUX 2
DATA 1	SYNC DATA 1	DATA AD3	SYNC AUX 3
DATA 2	SYNC DATA 2	DATA AD4	SYNC AUX 4
DATA 3	SYNC DATA 3	DATA AD5	SYNC AUX 5
DATA 4	SYNC DATA 4	DATA AD6	SYNC AUX 6

Sync Function Keystrokes  
Table 2



## 5.2 STANDARD TEST CONDITIONS

The following procedure is used to test MLS equipment. The Test Operational Menu used in this procedure includes the standard test signals used to test MLS equipment set forth by RTCA/DO-177, ED-53A and ED-36A.

- | STEP | PROCEDURE  |
|------|--|
| 1.   | Connect MLS-800-2 as shown in 1-2-1, Figure 2.   |
| 2.   | Set PWR/OFF/BATT Switch to PWR.  |
| 3.   | Press F1 on SPECIAL FUNCTION Keys to display Test Operational Menu.                              |
| 4.   | Verify accuracy of MLS Receiver under test to following standard test conditions and parameters: |

FIELD	SETTING
CHANNEL	600 (MHz)
RF LEVEL	-070 (dBm)
OCI	-4 (dB)
AZ ANGLE	00.00 (°)
EL ANGLE	03.00 (°)
SCANNING BEAM LEVEL	06 (dB)
SCANNING BEAM WIDTH	1 (°)
AZ TO THRESHOLD DISTANCE	3000 (Meters)
AZ PROP. COV. NEG. LIMIT (Data Word #1)	-60 (°)
AZ PROP. COV. POS. LIMIT (Data Word #1)	60 (°)
MIN. GLIDE PATH (Data Word #2)	3.0 (°)
GROUND STATION IDENTIFIER (Data Word #6)	IFR

### 5.3 DIAGNOSTIC MENU OPERATION

#### 5.3.1 General

The Diagnostic Menu is used for testing and alignment of the MLS-800-2. Test operations which cannot be accomplished in the Test Operational Menu are performed in the Diagnostic Menu.

Only one test (CRT Alignment, RF Channel or 429 Loop) is active at any one time. For 429 Loop Test, only one of the two channels is under test at one time. 429 Loop Test results are displayed to the right of the 429 Loop Test Field. For Beam Modulation tests (Main Path and Multipath), either test or both can run in any of the available modes and can run during the CRT Alignment, RF Channel or 429 Loop tests. At the completion of the RF Channel Test, the channel is restored to the value indicated in the Beam Modulation Test Channel Field. Refer to Maintenance Manual for Soft-Cal procedure.

The CRT Alignment, RF Channel and 429 Loop tests are displayed in reverse video when active. To start the CRT Alignment, RF Channel and 429 Loop tests, move cursor to and slew the field to the desired test condition and press ENTER Key. All commands must use the ENTER Key to maintain desired value selected with the DATA SLEW Keys. There are three ways to halt the CRT Alignment, RF Channel or 429 Loop test:

- Press DATA SLEW Keys to set field to OFF and press ENTER Key.
- Start up another test (CRT Alignment, RF Channel or 429 Loop).
- Press SPECIAL FUNCTION Keys to exit the Diagnostic Menu.

Only one of the top three fields under Beam Modulation Test can be active at any one time (Fade Rate, Prop Mod or 6.75 Hz). If one is activated, all other fields are disabled. If Main Path Beam is not OFF, Sync is applied to the Main Beam. Non-Azimuth Multipath Beams should be run with the Main Path Beam OFF. Fields related to each Beam Path are displayed in reverse video if active and relevant to the Modulation type.

The cursor can be moved while certain tests are executing (RF Channel, 429 Loop, Main Path or Multipath Test) and the test fields can be edited, although response to the editing inputs is slower.

## 5.3.2 CRT Alignment Test

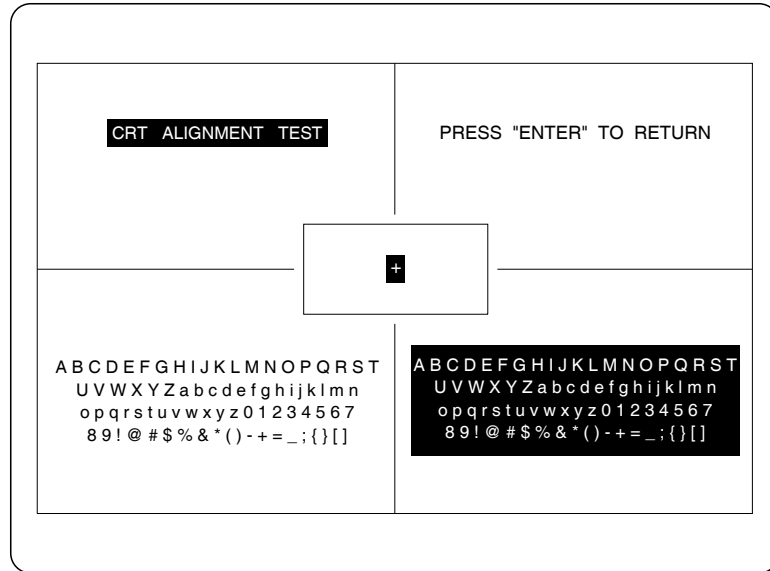

4810002

STEP	PROCEDURE
1.	Press F2 on SPECIAL FUNCTION Keys to display the Diagnostic Menu.
2.	Move cursor to CRT Alignment Test. Prompt Line CRT Alignment Test: SLEW-ENTER select ON or OFF appears.
3.	Press DATA SLEW Keys to toggle setting from OFF to ON. Press ENTER Key. CRT Alignment Test Screen appears.
4.	When adjustments are complete, press ENTER Key to return to Diagnostic Menu.

### 5.3.3 RF Channel Test

STEP	PROCEDURE
1.	Press F2 on SPECIAL FUNCTION Keys to display Diagnostic Menu.
2.	Move cursor to RF Channel Test. Prompt Line RF Channel Test: SLEW-ENTER select ON or OFF appears.
3.	Press DATA SLEW Keys to toggle setting from OFF to ON. Press ENTER Key to start RF Channel Test. Results are displayed on CYCLE and ERROR counters.
	<b>NOTE:</b> RF Synthesizer is stepped from Channel 500 to 699 and back in increments of 10. Cycle repeats at ≈1.5 sec.
4.	Press ENTER Key to end RF Channel Test.

### 5.3.4 429 Loop Test

STEP	PROCEDURE
1.	Press F2 on SPECIAL FUNCTION Keys to display Diagnostic Menu.
2.	Move cursor to 429 Loop Test. Prompt Line 429 Loop Test: SLEW-ENTER select ON or OFF appears.
3.	Press DATA SLEW Keys to toggle setting from OFF to CHAN #1 or CHAN #2.
4.	Press ENTER Key. Prompt Line Insert 429 test adaptor and ENTER; Press ESC to ignore appears at bottom of Diagnostic Menu.
5.	Insert 429 Test Adaptor in ARINC 429 BUS Connector.
6.	Press ENTER Key to start 429 Loop Test. Results are displayed on CYCLE and ERROR counters.
7.	Press DATA SLEW Keys to toggle setting to OFF. Press ENTER Key to end 429 Loop Test.
	<b>NOTE:</b> Upon completion of desired test cycles, CYCLE and ERROR counters restart when 429 Loop Test is reinstated.

## 6. REMOTE OPERATION (GPIB)

### 6.1 GENERAL

Remote communication with the MLS-800-2 is provided by use of the General Purpose Interface Bus (GPIB) which conforms to the IEEE-488-1978 Standard. The MLS-800-2 conforms to the following IEEE-488-1978 Subsets:

SH1	LA	PPØ
AH1	LEØ	DC1
T6	SR1	DT1
TEØ	RL2	CØ

The MLS-800-2 has the following capabilities using ASCII encoded character strings:

- Complete Source and Acceptor Handshake
- Talker with Serial Poll
- Listener
- Service Request
- Remote/Local (No Local Lockout Capability)
- Device Clear
- Device Trigger

The GPIB Address is set by the MLS-800-2 DATA ENTRY Keys in the Special Function Menu.

All communication with the MLS-800-2 over the GPIB is implemented with ASCII encoded character strings. Invalid or improperly formatted characters are discarded and an error status bit is set. The exceptions to this rule are the IEEE-488 defined BUS messages listed in 1-2-6, Table 4. Any of these messages causes an immediate response within the MLS-800-2. The ASCII String Commands are stored in a 128-Byte Buffer until receipt of a Carriage Return, Line Feed, Null Character or an END, IDY or GET message. At this time, all commands are executed.

#### 6.1.1 GPIB Transactions

Two examples of GPIB transactions showing the ASCII character string to be transmitted followed by the necessary BUS operations to complete the transactions are shown. These examples were generated and executed using a GPIB controller that uses an ANSI Standard Basic Interpreter with enhancements allowing direct communication over GPIB using special GPIB interface hardware. In the following examples, the ASCII character string to be transmitted is shown first, followed by the bus operations required to complete the transaction.

Example: **Channel to 699**

ASCII String is "CHNL=699"  
(Followed by carriage return and line feed.)

BUS Transaction is UNT, UNL, MTA, DAB "C", DAB "H", DAB "N", DAB "L", DAB "=", DAB "6", DAB "9", DAB CR, DAB LF.

Example: **Return RF Level (-100 dB)**

ASCII String is "RFLVL?"

BUS Transaction Output Cycle is UNT, UNL, MLA, MTA, DAB "R", DAB "F", DAB "L", DAB "V", DAB "L", DAB "?", DAB CR, DAB LF.

BUS Transaction Input Cycle is UNT, UNL, MLA, MTA, DAB "-", DAB "1", DAB "Ø", DAB "Ø", DAB CR, DAB LF.

**6.1.2 Status and Service Request Transactions**

The MLS-800-2 can trigger a service request, based on one to six trigger conditions which is set by the user with the "SRQ=" command.

When placed in remote operation mode, the MLS-800-2 can be interrogated for the one byte status information. If an internal error or status condition becomes true and the matching trigger bit of the SRQ trigger byte has been set, Bit 6 is set. Bit 6 is generally used as the service request bit, signaling the GPIB controller the MLS-800-2 desires servicing. For an explanation of the other bits returned through the Serial Poll, refer to 1-2-6, Table 3.

STATUS BIT NO.	STATE	DEFINITION
Ø	Ø = LOCAL 1 = REMOTE	Local/Remote Status
1	NOT DEFINED	Not Defined
2	Ø = LOCAL 1 = REMOTE	System Error Status
3	Ø = LOCAL 1 = REMOTE	429 Comm Error Status
4	NOT DEFINED	Not Defined
5	NOT DEFINED	Not Defined
6	Ø = LOCAL 1 = REMOTE	SRQ Trigger Status
7	NOT DEFINED	Not Defined

Status Bit Definition  
Table 3

For a description of the System Error Status, ERRM? is executed. The Warning or Error message is cleared when ERRM? is executed. The 429 Comm Error Status information is returned by STAT429?.



MNEMONIC MESSAGE	ASCII CODE (HEX)	IEEE 48 INSTRUCTION	DEFINITION
ATN	BUS SIGNAL LINE	ATTENTION	MLS-800-2 GPIB I/O Device responds to process incoming GPIB controller commands.
DAB	00-7F	DATA BYTE	MLS-800-2 CPU responds by status testing of OF GPIB I/O device to accept DATA BYTE.
DAC	BUS SIGNAL LINE	DATA ACCEPTED	MLS-800-2 GPIB I/O device responds immediately to signal talker of DATA BYTE acceptance.
DAV	BUS SIGNAL LINE	DATA VALID	MLS-800-2 GPIB I/O device responds to signal interceptor of valid data on bus.
DCL	14	DEVICE CLEAR	MLS-800-2 CPU responds to reset GPIB interface to individualized state.
END OR EOI	BUS SIGNAL LINE	END	MLS-800-2 responds to terminate command input from source and begins processing commands available up to last valid delimiter.
GET	08	GROUP EXECUTE TRIGGER	MLS-800-2 responds to terminate any further inputs and executes commands available up to last delimiter.
GTL	01	GO TO LOCAL	MLS-800-2 CPU responds to return control over to front panel.
IDY	BUS SIGNAL LINE	IDENTIFY	MLS-800-2 responds to terminate command input from source and begin processing commands available up to last delimiter valid.
IFC	BUS SIGNAL LINE	INTERFACE CLEAR	MLS-800-2 CPU responds by returning to local mode.
LLO			No response
MLA	20-3F	LISTEN ADDRESS	MLS-800-2 GPIB I/O device responds by comparing address with listen address given. If both are same, CPU is instructed to listen.
MTA	40-5F	TALK ADDRESS	MLS-800-2 GPIB I/O device responds by comparing address with talk address given. If both are same, CPU is instructed to talk.
REN	BUS SIGNAL LINE	REMOTE ENABLE	MLS-800-2 CPU responds from interface to put MLS-800-2 in remote, disabling front panel operation.
RFD	BUS SIGNAL LINE	READY FOR DATA	MLS-800-2 GPIB I/O device signals source for data to be transmitted on bus.
SPD	19	SERIAL POLL DISABLE	MLS-800-2 GPIB I/O device terminates service request operation by disabling serial poll.

MLS-800-2 GPIB Message Interface Definitions  
Table 4

<b>MNEMONIC MESSAGE</b>	<b>ASCII CODE (HEX)</b>	<b>IEEE 48 INSTRUCTION</b>	<b>DEFINITION</b>
SPE	18	SERIAL POLL ENABLE	MLS-800-2 GPIB I/O device places status byte on bus addressed to talk.
SRQ	BUS SIGNAL LINE	SERVICE REQUEST	MLS-800-2 CPU instructs interface to signal controller that servicing is desired. (Done under MLS-800-2 software control.)
STB	00-FF	STATUS BYTE	MLS-800-2 GPIB I/O device responds after SPE and MTA messages by placing status byte on bus.
UNL	3F	UNLISTEN	MLS-800-2 GPIB I/O device and CPU responds to UNLISTEN MLS-800-2.
UNT	5F	UNTALK	MLS-800-2 GPIB I/O device and CPU responds to UNTALK MLS-800-2.

MLS-800-2 GPIB Message Interface Definitions  
Table 4 (cont)



## 6.2 COMMAND AND DATA STRUCTURE

All MLS-800-2 functional commands and data information are transferred over the GPIB as uppercase ASCII Alphanumeric Character Strings and are designed to replace the front panel controls.

### 6.2.1 ASCII Output Commands to MLS-800-2

All input commands sent to the MLS-800-2 are placed on an Internal Stack that accommodates up to 128 bytes of data. Command strings can be packed together, but the individual commands must be separated by delimiters. The delimiters are as follows:

ASCII Semi Colon (;), Colon (:) or Slash (/)  
ASCII Period (.)  
ASCII Question Mark (?)

**NOTE:** The Semi Colon (;), Colon (:) or Slash (/) are general delimiters and can be used after the Period (.) or Question Mark (?). Care must be exercised in using the Period or Question Mark at the end of a command so as not to change the interpretation of that command. Upon receipt of the Slash (/), the command preceding is executed immediately.

- When the MLS-800-2 is the assigned listener, the following ASCII characters terminate the output command or series of commands:

ASCII Carriage Return (0D) - "CR"  
ASCII Line Feed (0A) - "LF"  
Null Character (0) - "NL"

- When the MLS-800-2 is the assigned talker, the EOI line is sent when the specified termination sequence is sent.

**NOTE:** TERM = XXXX specifies the termination sequence.

### 6.2.2 ASCII Output Command Data Format

All spaces are ignored. Examples of valid commands are as follows:

```
"MODE = NORMAZ: MODE?"
"UPDATE?"
"RFLVL = -100:"
```

**NOTE:** If no CR, LF, NULL, GET, SLASH or EOI is included, then the line can be continued and the commands are not executed until a delimiter is received.

Maximum command string length including spaces and delimiters is 128 characters. If the command string exceeds 128 characters, everything up to the most recent delimiter is accepted and the rest ignored. Commands ending with an ASCII Question Mark (?) normally requires the operator to input using an ASCII string input command after issuing the output command.

Example: "CHNL?UPDATE?RID=ON:  
RFLVL"

Response: "699:100:RFLVL=100?"

The commands in the previous example set the Reply Identifier Flag which caused the command label following "RID=ON" to be attached to the response.

### 6.2.3 Return Data Format

The returned data format convention is similar to the Output Command Data Format in that all returns are packed together and separated by ASCII Colon (:) delimiters. The number of responses returned is determined by the number of commands transferred in one block. If the number of responses required causes the internal response buffer to overflow by being larger than 128 bytes, then only the responses up to the most recent delimiter are returned. Data fields returned with commands are separated by Semi Colon (;) delimiters. Refer to ASCII Output Command Data Format for a response example.

Data inputs that are out of specific range generally default to the minimum values, maximum values or previous values.

### 6.2.4 Command Groups

The command mnemonics used in the MLS-800-2 are longer than normally seen in GPIB controlled equipment. This process is used to give the unfamiliar programmer a clear understanding of the functions they are executing. Because the possibility exists that the long transmission time required for these commands could seriously impede overall ATE systems performance, three command group buffers and associated commands (CGX=, CGX? and CGX.) have been included (X=1, 2 or 3). These groups allow the programmer to input up to 124 characters (128-CGX=) to one of three command buffers for later execution by CGX. CGX. can be stacked as long as there is not more than one CGX= input. As soon as the command input interpreter sees CGX., the command input interpreter immediately appends that command group buffer to the input buffer and proceeds with normal command interpretation and execution. An example of the proper usage of command buffer stacking is as follows:

Example:    "CG1=RID=ON:CHNL?"  
              "CG2=CHNL?CG."  
              "CG#=UPDATE?CG@."

Response:   100:699:CHNL=699

**NOTE:** Do not use the same numbers (1, 2 or 3) in commands (CG1, CG2 or CG3) within the same command group (e.g., "CG1 = XXX... CG1....". This causes a system failure.

### 5.2.5 Reply Identifier

When the Reply Identifier is activated by RID=ON, the returned information for data or status requests is preceded by the command mnemonic and a "=" character. This continues until RID=OFF is given or the MLS-800-2 power is cycled. This feature is especially useful for data returned from a series of commands.



**6.3 ALPHABETICAL QUICK REFERENCE  
ASCII COMMAND TABLE**

COMMAND	RANGE	PAGE
ADn= (n is 1, 2, 3, 4, 5 or 6)	ON or OFF;A1, A2, A3, A4, A5 or A6;(DATA); OOOOOOO to EEEEEEE	17
ADn? (n is 1, 2, 3, 4, 5 or 6)	Ø or 1;A1, A2, A3, A4, A5 or A6;(DATA); OOOOOOO to EEEEEEE	18
AZ=	ON or OFF;-62.00 to 62.00;-03 to 13;NORM or HALF; Ø.5, 1, 2, 3, 4 or 5	13
AZ?	ON or OFF;-62.00 to 62.00;-03 to 13;NORM or HALF; Ø.5, 1, 2, 3, 4 or 5	13
AZOCILT=	-4 to 7	12
AZOCILT?	-4 to 7	12
AZOCIRR=	-4 to 7	13
AZOCIRR?	-4 to 7	13
AZOCIRT=	-4 to 7	12
AZOCIRT?	-4 to 7	12
AZRAT=	Ø or -75	11
AZRAT?	Ø or -75	11
AZ429?	-62.000 to 62.000 or -----	12
BAZ=	ON or OFF;-42.00 to 42.00;-03 to 13;NORM or HALF; Ø.5, 1, 2, 3, 4 or 5	13
BAZ?	ON or OFF;-42.00 to 42.00;-03 to 13;NORM or HALF; Ø.5, 1, 2, 3, 4 or 5	13
BAZOCILT=	-4 to 7	13
BAZOCILT?	-4 to 7	13
BAZOCIRR=	-4 to 7	13
BAZOCIRR?	-4 to 7	13
BAZOCIRT=	-4 to 7	12
BAZOCIRT?	-4 to 7	12
BAZ429?	-42.000 to 42.000 or -----	12
CG1=	128 ASCII Characters	19
CG1?	128 ASCII Characters	19
CG1.	128 ASCII Characters	19
CG2=	128 ASCII Characters	19
CG2?	128 ASCII Characters	19
CG2.	128 ASCII Characters	19
CG3=	128 ASCII Characters	19
CG3?	128 ASCII Characters	19
CG3.	128 ASCII Characters	19
CHNL=	500 to 699	11
CHNL?	500 to 699	11
CMN?	-1.000 to 1.000 or -----	12
DW1=	Ø or 1;0000 to 6300;10 to 62;10 to 62;Ø or 1;Ø or 1; OO, OE, EO or EE	14
DW1?	Ø or 1;0000 to 6300;10 to 62;10 to 62;Ø or 1;Ø or 1; OO, OE, EO or EE	15
DW2=	Ø or 1;02.0 to 14.7;Ø or 1;Ø to 3;Ø or 1;Ø or 1;Ø to 63; OO, OE, EO or EE	15



COMMAND	RANGE	PAGE
DW2?	Ø or 1;Ø2.Ø to 14.7;Ø or 1;Ø to 3;Ø or 1;Ø or 1;Ø to 63; OO, OE, EO or EE	15
DW3=	Ø or 1;Ø.5 to 4.Ø;Ø.5 to 2.5;ØØØØ.Ø to 6387.5;Ø to 7; OO, OE, EO or EE	15
DW3?	Ø or 1;Ø.5 to 4.Ø;Ø.5 to 2.5;ØØØØ.Ø to 6387.5;Ø to 7; OO, OE, EO or EE	15
DW4=	Ø or 1;ØØØ to 359;ØØØ to 359;OO,OE, EO or EE	15
DW4?	Ø or 1;ØØØ to 359;ØØØ to 359;OO, OE, EO or EE	16
DW5=	Ø or 1;ØØ to 42;ØØ to 42;Ø.5 to 4.Ø;Ø or 1.Ø;to 15; OO, OE, EO or EE	16
DW5?	Ø or 1;ØØ to 42;ØØ to 42;Ø.5 to 4.Ø;Ø or 1.Ø;to 15; OO, OE, EO or EE	16
DW6=	Ø or 1;IFR;OO, OE, EO or EE	16
DW6?	Ø or 1;IFR;OO, OE, EO or EE	16
EL=	ON or OFF;-Ø1.5Ø to 29.5Ø;-Ø3 to 13;NORM or HALF; Ø.5, 1, 2, 3, 4 or 5	13
EL?	ON or OFF;-Ø1.5Ø to 29.5Ø;-Ø3 to 13;NORM or HALF; Ø.5, 1, 2, 3, 4 or 5	13
ELOCIRR=	-4 to 7	13
ELOCIRR?	-4 to 7	13
EL429?	-Ø1.5ØØ to 29.5ØØ or -----	12
ERRM?	1 through 8 or NO WARNING	20
FADE=	1ØØØ, 1, Ø.Ø5 or OFF	11
FADE?	1ØØØ, 1, Ø.Ø5 or OFF	11
FL=	ON or OFF;-Ø2.ØØ to 1Ø.ØØ;-Ø3 to 13;NORM or HALF; Ø.5, 1, 2, 3, 4 or 5	14
FL?	ON or OFF;-Ø2.ØØ to 1Ø.ØØ;-Ø3 to 13;NORM or HALF; Ø.5, 1, 2, 3, 4 or 5	14
FL429?	-Ø2.ØØØ to 29.5ØØ or -----	12
IDENT=	ON, OFF or CONT	11
IDENT?	ON, OFF or CONT	11
MODE=	NORMAZ or HIGHAZ	11
MODE?	NORMAZ or HIGHAZ	11
MP=	ON or OFF;-62.ØØ to 62.ØØ;-14 to 13; NORM, HALF or CLEAR;Ø.5, 1, 2, 3, 4 or 5;-Ø3 to 13; -Ø3 to 13;ØØ.ØØ to 62.ØØ	14
MP?	ON or OFF;-62.ØØ to 62.ØØ;-14 to 13; NORM, HALF or CLEAR;Ø.5, 1, 2, 3, 4 or 5;-Ø3 to 13; -Ø3 to 13;ØØ.ØØ to 62.ØØ	14
PAD?	ØØ to 11 or --	12
PFE?	-1.ØØØ to 1.ØØØ or -----	12
PPAR=	OO, OE, EO or EE	11
PPAR?	OO, OE, EO or EE	11
PROP=	OFF, ØØ1 to 199	11
PROP?	OFF, ØØ1 to 199	11
PURGE(nn).	Ø1 to 12	19
RECALL(nn).	Ø1 to 12	19
RFLVL=	-Ø17 to -122	11
RFLVL?	-Ø17 to -122	11



COMMAND	RANGE	PAGE
RID=	ON or OFF	19
RID?	ON or OFF	19
SAVE(nn)=	Ø1 to 12,A to Z, Ø to 9, -, # or Blank	19
SAVE(nn)?	8 ASCII Letters or Spaces	19
SDI?	ØØ to 11 or --	12
SRQ=	ØØØØØØØ to 1111111	19
SRQ?	ØØØØØØØ to 1111111	20
SSM?	ØØ to 11 or --	12
STAT429?	OE, ON or OFF	12
SYMM=	-6Ø to 6Ø	11
SYMM?	-6Ø to 6Ø	11
SYNC?	AZ, EL, BAZ, FL, DATA#1, DATA#2, DATA#3, DATA#4, DATA#5, DATA#6, DATAAD1, DATAAD2, DATAAD3, DATAAD4, DATAAD5 or DATAAD6	11
SYNCAD1.		14
SYNCAD2.		14
SYNCAD3.		14
SYNCAD4.		14
SYNCAD5.		14
SYNCAD6.		14
SYNCAZ.		11
SYNCBAZ.		11
SYNCDAT1.		11
SYNCDAT2.		11
SYNCDAT3.		11
SYNCDAT4.		11
SYNCDAT5.		11
SYNCDAT6.		11
SYNCEL.		11
SYNCFL.		11
SYNCOFF.		11
TERM=	CRLF, CRCR, LFCR, LFLF, LF or CR	19
TERM?	CRLF, CRCR, LFCR, LFLF, LF or CR	19
UPDATE=	Ø, 25, 45, 55, 75 or 1ØØ	11
UPDATE?	Ø, 25, 45, 55, 75 or 1ØØ	11
WPROT(nn).	Ø1 to 12	19
6.75=	ON or OFF	11
6.75?	ON or OFF	11

#### 6.4 COMMAND SET

The following paragraphs define the ASCII Commands used to control the MLS-800-2 under GPIB operation. The commands are grouped under paragraph headings according to the applicable function of each command.

Qualifiers for each command are used throughout the following paragraphs and are defined as follows:

"=" Is for a select operation.

"?" Is for a return operation.

"," Is for an enable operation.

Data listed under the range column reflects input/output data on the MLS-800-2. Data shown in parentheses is input data and data not shown in parentheses is output data.

COMMAND	RANGE	DEFINITION
<b>MENU FUNCTIONS</b>		
CHNL=	500 to 699	Selects setting for Channel Number.
CHNL?	500 to 699	Returns setting for Channel Number.
RFLVL=	-017 to -122	Selects setting for RF Power Output Level in dBm.
RFLVL?	-017 to -122	Returns setting for RF Power Output Level in dBm.
MODE=	NORMAZ or HIGHAZ	Selects setting for Mode of Operation.
MODE?	NORMAZ or HIGHAZ	Returns setting for Mode of Operation.
AZRAT=	0 or -75	Selects setting for AZ Beam Ratio in dB.
AZRAT?	0 or -75	Returns setting for AZ Beam Ratio in dB.
IDENT=	ON, OFF or CONT	Selects setting for Ident Tone as Active, Inactive or Continuous Tone State.
IDENT?	ON, OFF or CONT	Returns setting for Ident Tone as Active, Inactive or Continuous Tone State.
SYNCAZ.		Selects Sync on AZ Beam.
SYNCEL.		Selects Sync on EL Beam.
SYNCBAZ.		Selects Sync on BAZ Beam.
SYNCFL.		Selects Sync on FL Beam.
SYNCDAT1.		Selects Sync on Data Word #1.
SYNCDAT2.		Selects Sync on Data Word #2.
SYNCDAT3.		Selects Sync on Data Word #3.
SYNCDAT4.		Selects Sync on Data Word #4.
SYNCDAT5.		Selects Sync on Data Word #5.
SYNCDAT6.		Selects Sync on Data Word #6.
SYNCOFF.		Selects Sync Off.
SYNC?	AZ, EL, BAZ, FL, DATA#1, DATA#2, DATA#3, DATA#4, DATA#5, DATA#6, DATAAD1, DATAAD2, DATAAD3, DATAAD4, DATAAD5, DATAAD6	Returns setting of Sync.
PPAR=	OO, OE, EO or EE	Selects setting of Preamble Parity Bits (Even/Odd) for Sync Word/Beam.
PPAR?	OO, OE, EO or EE	Returns setting of Preamble Parity Bits (Even/Odd) for Sync Word/Beam.
UPDATE=	0, 25, 45, 55, 75 or 100	Selects setting for Update Rate in % of Transmissions for Sync Word/Beam.
UPDATE?	0, 25, 45, 55, 75 or 100	Returns setting for Update Rate in % of Transmissions for Sync Word/Beam.
SYMM=	-60 to 60	Selects setting for Offset of Sync Word/Beam in 1 $\mu$ s steps.
SYMM?	-60 to 60	Returns setting for Offset of Sync Word/Beam in 1 $\mu$ s steps.
6.75=	ON or OFF	Selects setting for 6.75 Hz.
6.75?	ON or OFF	Returns setting for 6.75 Hz.
FADE=	1000, 1, 0.05 or OFF	Selects setting for Fade Rate in Hz.
FADE?	1000, 1, 0.05 or OFF	Returns setting for Fade Rate in Hz.
PROP=	OFF or 001 to 199	Selects setting for Prop Mod in 1 Hz steps.
PROP?	OFF or 001 to 199	Returns setting for Prop Mod in 1 Hz steps.



COMMAND	RANGE	DEFINITION
PFE?	-1.000 to 1.000  -----	Returns value of measured Path Following Error in 0.001° Steps.  Returns 7 ASCII Dashes if no Data, value is >1 or Nothing in Sync.  Requires some Angle Function (i.e., AZ, EL, BAZ or FL) to be placed in Sync.
CMN?	-1.000 to 1.000  -----	Returns value of measured Control Motion Noise in 0.001° Steps.  Returns 7 ASCII Dashes if no Data, value is >1 or Nothing in Sync.  Requires some Angle Function (i.e., AZ, EL, BAZ or FL) to be placed in Sync.
SDI?	00 to 11  --	Returns Status of Bits 10 and 9 of 429 Word (Binary).  Returns 2 ASCII Dashes if no Data or Nothing in Sync.
PAD?	00 to 11  --	Returns Status of Bits 12 and 11 of 429 Word (Binary).  Returns 2 ASCII Dashes if no Data or Nothing in Sync.
SSM?	00 to 11  --	Returns Status of Bits 31 and 30 of 429 Word (Binary).  Returns 2 ASCII Dashes if no Data or Nothing in Sync.
STAT429?	OE, ON or OFF	Returns setting for Flag in 429 Mod.
AZ429?	-62.000 to 62.000  -----	Returns ARINC 429 AZ Data in 0.005° Steps.  Returns 7 ASCII Dashes if no Data.
EL429?	-01.500 to 29.500  -----	Returns ARINC 429 EL Data in 0.005° Steps.  Returns 7 ASCII Dashes if no Data.
FL429?	-02.000 to 29.500  -----	Returns ARINC 429 FL Data in 0.005° Steps.  Returns 7 ASCII Dashes if no Data.
BAZ429?	-42.000 to 42.000  -----	Returns ARINC 429 BAZ Data in 0.005° Steps.  Returns 7 ASCII Dashes if no Data.
AZOCIRT=	-4 to 7	Selects setting of Right OCI for AZ in dB.
AZOCIRT?	-4 to 7	Returns setting of Right OCI for AZ in dB.
BAZOCIRT=	-4 to 7	Selects setting of Right OCI for BAZ in dB.
BAZOCIRT?	-4 to 7	Returns setting of Right OCI for BAZ in dB.
AZOCILT=	-4 to 7	Selects setting of Left OCI for AZ in dB.
AZOCILT?	-4 to 7	Returns setting of Left OCI for AZ in dB.





COMMAND	RANGE	DEFINITION
BAZOCILT=	-4 to 7	Selects setting of Left OCI for BAZ in dB.
BAZOCILT?	-4 to 7	Returns setting of Left OCI for BAZ in dB.
AZOCIRR=	-4 to 7	Selects setting of Rear OCI for AZ in dB.
AZOCIRR?	-4 to 7	Returns setting of Rear OCI for AZ in dB.
ELOCIRR=	-4 to 7	Selects setting of Rear OCI for EL in dB.
ELOCIRR?	-4 to 7	Returns setting of Rear OCI for EL in dB.
BAZOCIRR=	-4 to 7	Returns setting of Rear OCI for BAZ in dB.
BAZOCIRR?	-4 to 7	Returns setting of Rear OCI for BAZ in dB.
AZ=	ON or OFF; -62.00 to 62.00; -03 to 13; NORM or HALF; 0.5, 1, 2, 3, 4 or 5	Selects settings for AZ Beam:  Cond Angle (0.05° steps) Level (dB Preamble) Shape Width (°)
AZ?	ON or OFF; -62.00 to 62.00; -03 to 13; NORM or HALF; 0.5, 1, 2, 3, 4 or 5	Returns settings for AZ Beam:  Cond Angle (0.05° steps) Level (dB Preamble) Shape Width (°)
EL=	ON or OFF; -01.50 to 29.50; -03 to 13; NORM or HALF; 0.5, 1, 2, 3, 4 or 5	Selects settings for EL Beam:  Cond Angle (0.05° steps) Level (dB) Shape Width (°)
EL?	ON or OFF; -01.50 to 29.50; -03 to 13; NORM or HALF; 0.5, 1, 2, 3, 4 or 5	Returns settings for EL Beam:  Cond Angle (0.05° steps) Level (dB) Shape Width (°)
BAZ=	ON or OFF; -42.00 to 42.00; -03 to 13; NORM or HALF; 0.5, 1, 2, 3, 4 or 5	Selects settings for BAZ Beam:  Cond Angle (0.05° steps) Level (dB) Shape Width (°)
BAZ?	ON or OFF; -42.00 to 42.00; -03 to 13; NORM or HALF; 0.5, 1, 2, 3, 4 or 5	Returns settings for BAZ Beam:  Cond Angle (0.05° steps) Level (dB) Shape Width (°)



COMMAND	RANGE	DEFINITION
FL=	ON or OFF; -02.00 to 10.00; -03 to 13; NORM or HALF; 0.5, 1, 2, 3, 4 or 5	Selects settings for FL Beam:  Cond Angle (0.05° steps) Level (dB) Shape Width (°)
FL?	ON or OFF; -02.00 to 10.00; -03 to 13; NORM or HALF; 0.5, 1, 2, 3, 4 or 5	Returns settings for FL Beam:  Cond Angle (0.05° steps) Level (dB) Shape Width (°)
MP=	ON or OFF; -62.00 to 62.00; -14 to 13; NORM, HALF or CLEAR; 0.5, 1, 2, 3, 4 or 5; -03 to 13; -03 to 13; 00.00 to 62.00,	Selects settings for MP Beam:  Cond Angle (0.05° steps) Level (dB) Shape Width (°) Left dB Right dB Angle (0.05° steps)  Last 3 items apply to Shape set to Clear.
MP?	ON or OFF; -62.00 to 62.00; -14 to 13; NORM, HALF or CLEAR; 0.5, 1, 2, 3, 4 or 5; -03 to 13; -03 to 13; 00.00 to 62.00	Returns settings for MP Beam:  Cond Angle (0.05° steps) Level (dB) Shape Width (°) Left dB Right dB Angle (0.05° steps)  Last 3 items apply to Shape set to Clear.
SYNCAD1.		Selects Sync on Aux Data #1.
SYNCAD2.		Selects Sync on Aux Data #2.
SYNCAD3.		Selects Sync on Aux Data #3.
SYNCAD4.		Selects Sync on Aux Data #4.
SYNCAD5.		Selects Sync on Aux Data #5.
SYNCAD6.		Selects Sync on Aux Data #6.
DW1=	0 or 1; 0000 to 6300; 10 to 62; 10 to 62; 0 or 1; 0 or 1; OO, OE, EO or EE	Selects settings for Data Word #1:  Enable Switch (0 is ON, 1 is OFF) AZ to Threshold Distance (100 Meter steps) AZ Prop. Cov. Neg. Limit (2° steps) AZ Prop. Cov. Pos. Limit (2° steps) Spare (1 Bit) Clr. Sig. Parity (Odd or Even)



COMMAND	RANGE	DEFINITION
DW1?	<p>Ø or 1;            0000 to 6300;            10 to 62;            10 to 62;            Ø or 1;            Ø or 1;            OO, OE, EO or EE</p>	<p>Returns settings for Data Word #1:            Enable Switch (Ø is ON, 1 is OFF)            AZ to Threshold Distance (100 Meter steps)            AZ Prop. Cov. Neg. Limit (2° steps)            AZ Prop. Cov. Pos. Limit (2° steps)            Spare (1 Bit)            Clr. Sig.            Parity (Odd or Even)</p>
DW2=	<p>Ø or 1;            02.0 to 14.7;            Ø or 1;            Ø to 3;            Ø or 1;            Ø or 1;            Ø to 63;            OO, OE, EO or EE</p>	<p>Selects settings for Data Word #2:            Enable Switch (Ø is ON, 1 is OFF)            Min Glide Path (0.1° steps)            BAZ Status            DME Status (Binary)            AZ Status            EL Status            Spare (6 Bits) (Binary)            Parity (Odd or Even)</p>
DW2?	<p>Ø or 1;            02.0 to 14.7;            Ø or 1;            Ø to 3;            Ø or 1;            Ø or 1;            Ø to 63;            OO, OE, EO or EE</p>	<p>Returns settings for Data Word #2:            Enable Switch (Ø is ON, 1 is OFF)            Min Glide Path (0.1° steps)            BAZ Status            DME Status (Binary)            AZ Status            EL Status            Spare (6 Bits) (Binary)            Parity (Odd or Even)</p>
DW3=	<p>Ø or 1;            0.5 to 4.0;            0.5 to 2.5;            0000.0 to 6387.5;            Ø to 7;            OO, OE, EO or EE</p>	<p>Selects settings for Data Word #3:            Enable Switch (Ø is ON, 1 is OFF)            AZ Beamwidth (0.5° steps)            EL Beamwidth (0.5° steps)            DME Distance (12.5 Meter steps)            Spare (3 Bits) (Binary)            Parity (Odd or Even)</p>
DW3?	<p>Ø or 1;            0.5 to 4.0;            0.5 to 2.5;            0000.0 to 6387.5;            Ø to 7;            OO, OE, EO or EE</p>	<p>Returns settings for Data Word #3:            Enable Switch (Ø is ON, 1 is OFF)            AZ Beamwidth (0.5° steps)            EL Beamwidth (0.5° steps)            DME Distance (12.5 Meter steps)            Spare (3 Bits) (Binary)            Parity (Odd or Even)</p>
DW4=	<p>Ø or 1;            000 to 359;            000 to 359;            OO, OE, EO or EE</p>	<p>Selects settings for Data Word #4:            Enable Switch (Ø is ON, 1 is OFF)            AZ Zero-Degree Guidance Plane (1° steps)            BAZ Zero-Degree Guidance Plane (1° steps)            Parity (Odd or Even)</p>

COMMAND	RANGE	DEFINITION
DW4?	<p>Ø or 1;            000 to 359;            000 to 359;            OO, OE, EO or EE</p>	<p>Returns settings for Data Word #4:            Enable Switch (Ø is ON, 1 is OFF)            AZ Zero-Degree Guidance Plane (1° steps)            BAZ Zero-Degree Guidance Plane (1° steps)            Parity (Odd or Even)</p>
DW5=	<p>Ø or 1;            00 to 42;            00 to 42;            0.5 to 4.0;            Ø to 1;            Ø to 15;            OO, OE, EO or EE</p>	<p>Selects settings for Data Word #5:            Enable Switch (Ø is ON, 1 is OFF)            BAZ Prop. Cov. Neg. (2° steps)            BAZ Prop. Cov. Pos. (2° steps)            BAZ Beamwidth (0.5° steps)            BAZ Status            Spare (4 Bits) (Binary)            Parity (Odd or Even)</p>
DW5?	<p>Ø or 1;            00 to 42;            00 to 42;            0.5 to 4.0;            Ø to 1;            Ø to 15;            OO, OE, EO or EE</p>	<p>Returns settings for Data Word #5:            Enable Switch (Ø is ON, 1 is OFF)            BAZ Prop. Cov. Neg. (2° steps)            BAZ Prop. Cov. Pos. (2° steps)            BAZ Beamwidth (0.5° steps)            BAZ Status            Spare (5 Bits) (Binary)            Parity (Odd or Even)</p>
DW6=	<p>Ø or 1;            IFR;            OO, OE, EO or EE</p>	<p>Selects settings for Data Word #6:            Enable Switch (Ø is ON, 1 is OFF)            Ground Station ID (User Definable)            Parity (Odd or Even)</p>
DW6?	<p>Ø or 1;            IFR;            OO, OE, EO or EE</p>	<p>Returns settings for Data Word #6:            Enable Switch (Ø is ON, 1 is OFF)            Ground Station ID (User Definable)            Parity (Odd or Even)</p>

COMMAND	RANGE	DEFINITION
ADn=  (n is 1, 2, 3, 4, 5 or 6)	<p>∅ or 1;</p> <p>A1; -511 to 511; ∅∅∅∅ to 8191; -2∅.47 to 2∅.47; ∅ or 1; -63 to 63; ∅∅ to 77;</p> <p>A2; -511 to 511; ∅∅∅∅ to 1∅23; -6.3 to 6.3; -4095 to 4095; -6.3 to 6.3;</p> <p>∅ to 3;</p> <p>A3; -2∅47 to 2∅47; -8191 to 8191; -63 to 63; ∅∅∅∅∅ to 16383; ∅ to 3;</p> <p>A4; -511 to 511; ∅∅∅∅ to 2047; -2∅.47 to 2∅.47; ∅ to 1; -63 to 63; ∅∅∅ to 377;</p> <p>A5; ∅∅∅∅ to 2555; ∅∅∅∅ to 2555; ∅∅∅∅ to 2555; ∅∅∅∅ to 127; ∅∅∅∅ to 359;</p> <p>A6; ∅∅∅ to 377; ∅∅∅ to 377; ∅∅∅ to 377; ∅∅∅ to 377; ∅∅∅ to 377; ∅∅∅ to 377; ∅∅∅ to 377; ∅ to 1;</p> <p>∅∅∅∅∅∅ to EEEEEEE</p>	<p>Selects settings for Auxiliary Data Word:</p> <p>Enable Switch (∅ is ON, 1 is OFF)</p> <p>Data Type AZ Ant. Offset (1 Meter steps) AZ to MLS Datum (1 Meter steps) AZ Ant. Align. (0.01° steps) AZ Ant. Co-ord. Approach AZ Ant Height (1 Meter steps) Spare (2 Bits) (Octal)</p> <p>Data Type EL Antenna Offset (1 Meter steps) MLS Datum to Thresh. (1 Meter steps) EL Ant. Height (0.1 Meter steps) MLS Datum EL Ref. MLS (1 Meter steps) Runway Threshold Height (0.1 Meter steps) Spare (1 Bit)</p> <p>Data Type DME Offset (1 Meter steps) DME to MLS Datum (1 Meter steps) DME Ant. Height (1 Meter steps) Runway Stop-end Distance (1 Meter steps) Spare (1 Bit)</p> <p>Data Type BAZ Ant. Offset (1 Meter steps) BAZ to MLS Datum (1 Meter steps) BAZ Ant. Align. (0.01° steps) BAZ Ant. Co-ord BAZ Ant. Height (1 Meter steps) Spare (3 Bits) (Octal)</p> <p>Data Type RVR (TD Zone) (5 Meter steps) RVR (Midpoint) (5 Meter steps) RVR (Stop-end) (5 Meter steps) Surface Wind Speed (1 Noeud steps) Surface Wind Dir. (Magnetic) (1° steps)</p> <p>Data Type Addr Data -1 Data -2 Data -3 Data -4 Data -5 Data -6 Data -7</p> <p>Parity (Odd or Even)</p>

COMMAND	RANGE	DEFINITION
ADn?  (n is 1, 2, 3, 4, 5 or 6)	<p>Ø or 1;</p> <p>A1; -511 to 511; ØØØØ to 8191; -2Ø.47 to 2Ø.47; Ø or 1; -63 to 63; ØØ to 77;</p> <p>A2; -511 to 511; ØØØØ to 1Ø23; -6.3 to 6.3; -4095 to 4095; -6.3 to 6.3;</p> <p>Ø to 3;</p> <p>A3; -2Ø47 to 2Ø47; -8191 to 8191; -63 to 63; ØØØØØ to 16383; Ø to 3;</p> <p>A4; -511 to 511; ØØØØ to 2047; -2Ø.47 to 2Ø.47; Ø to 1; -63 to 63; ØØØ to 377;</p> <p>A5; ØØØØ to 2555; ØØØØ to 2555; ØØØØ to 2555; ØØØØ to 127; ØØØØ to 359;</p> <p>A6; ØØØ to 377; ØØØ to 377; ØØØ to 377; ØØØ to 377; ØØØ to 377; ØØØ to 377; ØØØ to 377; ØØØ to 377; Ø to 1;</p> <p>OOOOOOO to EEEEEEE</p>	<p>Selects settings for Auxiliary Data Word:</p> <p>Enable Switch (Ø is ON, 1 is OFF)</p> <p>Data Type AZ Ant. Offset (1 Meter steps) AZ to MLS Datum (1 Meter steps) AZ Ant. Align. (0.01° steps) AZ Ant. Co-ord. Approach AZ Ant Height (1 Meter steps) Spare (2 Bits) (Octal)</p> <p>Data Type EL Antenna Offset (1 Meter steps) MLS Datum to Thresh. (1 Meter steps) EL Ant. Height (0.1 Meter steps) MLS Datum EL Ref. MLS (1 Meter steps) Runway Threshold Height (0.1 Meter steps) Spare (1 Bit)</p> <p>Data Type DME Offset (1 Meter steps) DME to MLS Datum (1 Meter steps) DME Ant. Height (1 Meter steps) Runway Stop-end Distance (1 Meter steps) Spare (1 Bit)</p> <p>Data Type BAZ Ant. Offset (1 Meter steps) BAZ to MLS Datum (1 Meter steps) BAZ Ant. Align. (0.01° steps) BAZ Ant. Co-ord BAZ Ant. Height (1 Meter steps) Spare (3 Bits) (Octal)</p> <p>Data Type RVR (TD Zone) (5 Meter steps) RVR (Midpoint) (5 Meter steps) RVR (Stop-end) (5 Meter steps) Surface Wind Speed (1 Noeud steps) Surface Wind Dir. (Magnetic) (1° steps)</p> <p>Data Type Addr Data -1 Data -2 Data -3 Data -4 Data -5 Data -6 Data -7</p> <p>Parity (Odd or Even)</p>



COMMAND	RANGE	DEFINITION
<b>KEYBOARD FUNCTIONS NOT INCLUDED IN MENU FUNCTIONS</b>		
RECALL(nn).	Ø1 to 12	Recalls Menu from MLS Memory.
SAVE(nn)=	Ø1 to 12 A to Z, Ø to 9, -, # or Blank	Stores Menu in MLS Memory with 8 Character Label.
SAVE(nn)?	8 ASCII Characters or Spaces	Returns 8 Character Label for Menu in MLS Memory.
WPROT(nn).	Ø1 to 12	Applies Write Protection to Menu in MLS Memory.
PURGE(nn).	Ø1 to 12	Erases Menu in MLS Memory.
<b>SPECIAL FUNCTIONS</b>		
CG1=	128 ASCII Characters	Stores MLS-800-2 GPIB Commands for Later Execution.
CG1?	128 ASCII Characters	Returns contents of CG1.
CG1.	128 ASCII Characters	Executes Commands Stored in CG1 Internal Buffer.
CG2=	128 ASCII Characters	Stores MLS-800-2 GPIB Commands for Later Execution.
CG2?	128 ASCII Characters	Returns contents of CG2.
CG2.	128 ASCII Characters	Executes Commands Stored in CG2 Internal Buffer.
CG3=	128 ASCII Characters	Stores MLS-800-2 GPIB Commands for Later Execution.
CG3?	128 ASCII Characters	Returns contents of CG3.
CG3.	128 ASCII Characters	Executes Commands Stored in CG3 Internal Buffer.
RID=	ON or OFF	Selects setting for Controls Reply Identifier Switch.  Adds Command Name followed by "=" as a Prefix to a Command's Response.
RID?	ON or OFF	Returns setting for RID.
TERM=	CRLF, CRCR, LFCR, LFLF, LF or CR	Selects Terminator for End-of-String Output.  CR is Carriage Return. LF is Line Feed.
TERM?	CRLF, CRCR, LFCR, LFLF, LF or CR	Returns Terminator for End-of-String Output.  CR is Carriage Return. LF is Line Feed.
SRQ=	ØØØØØØØ to 1111111	Selects GPIB SRQ Line Interrupt Mask (Binary).  An SRQ Interrupt occurs for each Error or Status Condition that Occurs whose Status Bit has been Set (1). Error/Status Conditions are shown in 1-2-6, Table 5.

COMMAND	RANGE	DEFINITION
SRQ?	00000000 to 11111111	<p>Returns GPIB SRQ Line Interrupt Mask (Binary).</p> <p>An SRQ Interrupt occurs for each Error or Status Condition whose Status Bit has been Set (1). Error/Status Conditions are shown in 1-2-6, Table 5.</p>
ERRM?	<ol style="list-style-type: none"> <li>1. DATA OUT OF RANGE</li> <li>2. INVALID COMMAND</li> <li>3. FUNCTION IN SYNC IS OFF</li> <li>4. MAIN BEAM BOARD INACTIVE</li> <li>5. MULTIPATH BEAM BOARD INACTIVE</li> <li>6. INVALID PAGE NUMBER</li> <li>7. PAGE IS WRITE-PROTECTED</li> <li>8. PAGE IS EMPTY</li> </ol> <p>NO WARNING</p>	<p>Returns Warning or System Error message.</p> <p>Warning or System Error Message is cleared when command is executed.</p>



**Special Notes:**

**MP= Command:** When sending the MP= command, utilizing CLEAR (clearance) function, use the following protocol...

MP=ON;;;CLEAR;;09;09;45.00

Use semi colons (;) to delimit the unused fields when CLEAR (clearance) is selected.

**MP? Command:** After sending the MP? command and reading back the ASCII string, the correct confirmation of the command string for the clearance parameters are returned. Note that the last MP normal or half beam angle, level and beam width are confirmed but are not used in the clearance mode of operation (i.e., MP=ON;00.00;-14;CLEAR;1;09;09;45.00).

**OCI parameters:** When setting the OCI fields to positive numbers (i.e., AZOCILT=05), ensure a leading 0 (zero) precedes the setting. This prevents single digit positive numbers being returned twice (i.e., 5 being returned as 55). When performing a read back (i.e., AZOCILT?), negative numbers should be entered as single digits.

BIT(S)	STATE	CONDITION
0	0 = LOCAL	LOCAL/REMOTE STATUS
1	NOT DEFINED	
2	0 = NO ERROR 1 = ERROR	SYSTEM ERROR STATUS
3	0 = NO ERROR 1 = ERROR	429 COMM ERROR STATUS
4	NOT DEFINED	
5	NOT DEFINED	
6	0 = NOT TRIGGERED 1 = TRIGGERED	SRQ TRIGGER STATUS
7	NOT DEFINED	

Error/Status Conditions  
Table 5



THIS PAGE INTENTIONALLY LEFT BLANK

## SECTION 3 - SPECIFICATIONS

**NOTE:** Unless otherwise noted the following equipment performance characteristics are warranted over the specified environmental conditions following a 20 minute warm-up period.

**NOTE:** All RF measurements are referenced to 50  $\Omega$ .

**NOTE:** Accuracy and resolution stated in percent are referenced to measured or desired values.

**NOTE:** Where resolution exceeds accuracy, resolution takes precedence.

### 1. GENERAL

#### 1.1 RF SIGNAL GENERATOR

Frequency Range: 5031 to 5090.7 MHz  
 Steps: 0.3 MHz  
 Accuracy:  $\pm 1.0$  kHz (measured with Main Path in CW and Multipath OFF)

#### RF Output Power:

Level Range: -17 to -122 dBm  
 Level Accuracy:  $\pm 2.0$  dB  
 Level Flatness:  $\pm 0.5$  dB at -20 dBm  
 (measured with 1000 Hz Fade Rate applied to Multipath with Multipath OFF, 14 dB Pad applied, and Main Path in CW, 0 dB modulation)

**NOTE:** A 0.2 to 0.4 dB variation in level at Fade Rate is normal operation and is due to residual component of Multipath signal. 0.8 dB variation is normal for Multipath signal at Multipath = 0 dB, Main Path = OFF.

Attenuator Accuracy:  $\pm 1.0$  dB  
 Attenuator Monotonicity:  $\pm 0.5$  to 1.5 dB (each step)

#### Spectral Purity:

Noise Floor Offset: -105 dBc/Hz ( $\pm 0.3$  to 1.2 MHz from  $C_f$ )

**NOTE:** 105 dBc/Hz is approximately equal to -60 dBc in a 30 kHz bandwidth.

**NOTE:** Total spurious power should not exceed -15 dBc or -35 dBm at -20 dBm level setting from 50.0 kHz to 12.4 GHz.

Residual FM Modulation: <1 kHz peak, 0.01 to 15 kHz BW

Residual Phase Modulation: <0.5 radians peak, 0.3 to 15 kHz BW

#### Spurious Signal Rejection (in-band):

$\pm 0.3$  to 1.2 MHz: -45 dBc  
 $\pm 1.2$  to 30 MHz (band end): -65 dBc

### 1.1 RF SIGNAL GENERATOR (cont)

Spurious Signal Rejection  
(out-of-band):

5120 to 5250 MHz	-50 dBm
50 kHz to 12.4 GHz:	-35 dBm (excluding 5000 to 5250 MHz)

### 1.2 MODULATION

**NOTE:** Angular range is limited to slightly less than maximum range with a beam width of 0.5° and 1.0° according to the following table:

FUNCTION	RANGE (0.5°)	RANGE (1.0°)
AZ	-61° to 61°	-61.95° to 61.95°
HiAZ	-41° to 41°	-41.95° to 41.95°
EL	-1.0° to 29.5°	-1.0° to 29.5°
BAZ	-41.75° to 41.75°	-41.75° to 41.75°
FL	-1° to 9°	-1° to 9°

**NOTE:** RF preamble level plus modulation level should not exceed -10.0 dBm.

**NOTE:** Beam modulation level of +6 dB above preamble is assumed unless specified.

Main Path Functions:

Beam Angles:

Azimuth:	±62°
High Rate Azimuth:	±42°
Elevation:	-1.5° to +29.5°
Flare:	-2° to +10°
Back Azimuth:	±42°
Angle Resolution:	±0.05° steps
Angle Accuracy:	±0.005°
Basic Data:	All functions selectable on menu with selectable data values and parity

Auxiliary Data: All auxiliary data words selectable

Beam Shape: Approximately  $\sin x/x$  or  $1/2 \sin x/x$  waveforms at  $1/2$  width that fills time slot. Sidelobes for  $1/2 \sin x/x$  are present on pulse side only.

Beam Width: 0.5°, 1°, 2°, 3°, 4°, 5°

Accuracy: ±10% of setting

Beam Level: Adjustable relative to preamble

Range: -3.0 to +13.0 dB

**NOTE:** RF preamble level plus modulation level should not exceed -10.0 dBm.

Resolution: 1.0 dB steps

Accuracy: ±1.0 dB

## 1.2 MODULATION (cont)

Side Lobes:	Relative to beam level
Level:	-20.0 dB ( $\pm 1.0$ dB)
OCI Pulses (Right, Left, Rear):	
Width:	100 $\mu$ s ( $\pm 10$ $\mu$ s)
Level:	Adjustable relative to preamble
Range:	-4.0 to +7.0 dB
Resolution:	1.0 dB steps
Accuracy:	$\pm 1.0$ dB
DPSK Modulation:	
Phase Shift:	
Logic Zero (0):	No transition
Logic One (1):	180° ( $\pm 10^\circ$ )
Amplitude Balance:	$\pm 0.4$ dB
Transition Time:	<10 $\mu$ s (10% to 90%)
Multipath Function:	
Beam Angle:	Selectable to maximum angle for selected function.
Angle Resolution	0.05° steps
Angle Accuracy	$\pm 0.05^\circ$
Beam Shape:	Approximately $\sin x/x$ or $1/2 \sin x/x$ waveforms at $1/2$ width that fills time slot. Sidelobes for $1/2 \sin x/x$ are present on pulse side only.
Beam Width:	0.5°, 1°, 2°, 3°, 4° and 5°
Accuracy:	$\pm 10\%$ of setting
Beam Level:	Adjustable relative to preamble
<b>NOTE:</b> RF preamble level plus modulation level should not exceed -10.0 dBm.	
<b>NOTE:</b> When clearance is selected, each pulse is individually selectable in amplitude.	
<b>NOTE:</b> Combined modulation level in a given time slot not to exceed +15 dB relative to preamble. Includes main path + multipath + 6.75 Hz modulation.	
Range:	-14.0 to +13.0 dB
Resolution:	1.0 dB steps
Accuracy:	$\pm 1.0$ dB (-3.0 to +13.0 dB) $\pm 2.0$ dB (-14.0 to -4.0 dB)
Side Lobes:	Relative to beam level
Level:	-20.0 dB ( $\pm 1.0$ dB)
Main Path to Multipath:	$\pm 1.0$ dB tracking error

## 1.2 MODULATION (cont)

### Fade Rate:

Frequency:	0.05, 1 and 1000 Hz (selectable)
Accuracy:	±1%
Steps:	Eight discrete steps that approximate a sine wave

### Clearance Pulses:

**NOTE:** Selectable for AZ, HiAZ and BAZ functions only. Angular range is ±1° to ±61° for AZ and ±41° for HiAZ and BAZ.

Position:	Two pulses spaced equidistant from 0.0°.
Angle Resolution:	±0.05°
Angle Accuracy:	±0.05°

Pulse Width: 50.0 μs (±5.0 μs)

### Amplitude:

Range:	-3.0 to +13.0 dB
Resolution:	1.0 dB steps
Accuracy:	±1.0 dB

## 1.3 ADDITIONAL FUNCTIONS

AZ to EL Ratio: Selectable so Azimuth to Elevation function ratio is 0 or -75 dB

Accuracy: ±2 dB

### Interference Modulation:

#### Propeller Modulation:

Frequency:	Variable 1 to 199 Hz
Resolution:	1.0 Hz steps
Accuracy:	±1%
Duty Cycle:	-12 dB (±2 dB) applied for 15% (±1%)
Sync:	Not in sync with any function

#### 6.75 Hz Modulation:

Frequency:	6.75 Hz
Accuracy:	±1%
Level:	Selectable ±6.0 dB square wave modulation to main beam

**NOTE:** RF preamble level plus modulation level should not exceed -10.0 dBm.

**NOTE:** Combined modulation level in a given time slot not to exceed +15 dB relative to preamble. Includes main path + multipath + 6.75 Hz modulation.

Accuracy:	±1.0 dB
Sync:	Not in sync with any function

### Morse Code:

Selection: Off, IFR or Continuous Tone

### 1.3 ADDITIONAL FUNCTIONS (cont)

Oscilloscope Sync:

Selection: Selectable to occur at start of any function, basic or auxiliary data word

Amplitude: Positive TTL pulse approximately 14  $\mu$ s wide

**NOTE:** Sync control specifies to which function or data word the tests in 1-3-1, Table 1 apply.

FUNCTION	APPLICATION
P PARITY	Controls Preamble Parity
6.75 Hz	Enables or disables 6.75 Hz Modulation
UPDATE	Controls % update rate
FADE RATE	Controls Fade Rate (applied to Multipath Beam)
SYMMETRY	Controls Beam Symmetry
PROP MOD	Controls Propeller Modulation Frequency
PFE	Measurement of Path Following Error
CMN	Measurement of Control Motion Noise

Oscilloscope Sync Amplitude  
Table 1

Function Update Rate:

Selection: 100%, 75%, 55%, 45%, 25% and 0%

Accuracy:  $\pm$ 3.9%

FUNCTION	UPDATE RATE	AVERAGE RATE OVER 10 SEC
AZ	100%	13 Hz ( $\pm$ 0.5 Hz)
HiAZ	100%	39 Hz ( $\pm$ 1.5 Hz)
BAZ	100%	6.5 Hz ( $\pm$ 0.25 Hz)
EL	100%	39 Hz ( $\pm$ 1.5 Hz)

Function Preamble Parity:

Selection: Function identified by Oscilloscope Sync selection is candidate to have its parity bits individually inverted to provide a change in parity

Scanning Beam Time Symmetry:

Selection: 0 (OFF),  $\pm$ 60  $\mu$ s in 1  $\mu$ s steps referenced to proper timing from preamble Receiver Time Reference Code

External Reference Input: Variable 9.999940 to 10.000060 MHz at 3 dB nominal

ARINC 429 Receiver:

Rates: 12.5 and 100 kbps data rates

Format: Return to Zero (RZ)

Levels: Logic "1" = +5 to +10 V input, typical  
Logic "0" = -5 to -10 V input, typical

Transitions: Rise and fall times <1.5  $\mu$ s

GPIB: Conforms to IEEE-488-1978 Standard for Talker/Listener



## 1.4 POWER

### AC:

Voltage:	103.5 to 240.0 VAC
Frequency:	45.0 to 440 Hz
Power Consumption:	85.0 W, maximum
Fuse Requirements:	2.5 A, 250 V, Type F

### DC:

Voltage:	11.0 to 30.0 Vdc
Fuse Requirements:	7.5 A, 32 V minimum, Type F

### Battery:

Time Out: 10 minute time out circuit to prevent accidental discharge. Low voltage detect turns unit off prior to performance being affected.

Charge Cycle: At least 3 cycles or 30 minutes of charge life before recharge.

### Environmental:

Weight:	50 lbs. Maximum (22.68 kg)
Dimension (with lid):	21.25 in (H) x 14.0 in (L) x 9.25 in (W) 53.98 cm (H) x 35.56 cm (L) x 23.5 cm (W)
Operating Temperature:	50°F to 104°F (+10°C to +40°C)
Storage Temperature:	-40°F to 160°F (-40°C to +71°C)



## SECTION 4 - SHIPPING

### 1. SHIPPING TEST SETS

#### 1.1 INFORMATION

Test Sets returned to factory for calibration, service or repair must be repackaged and shipped according to the following conditions:

##### Authorization

Do not return any products to factory without first receiving authorization from Aeroflex Customer Service Department.

##### CONTACT:

Aeroflex  
Customer Service  
  
Phone: (800) 835-2350  
FAX: (316) 529-5330  
Email: [americas.service@aeroflex.com](mailto:americas.service@aeroflex.com)

##### Tagging Test Sets

All Test Sets must be tagged with:

- Identification and address of owner
- Nature of service or repair required
- Model Number
- Serial Number

##### Shipping Containers

Test Sets must be repackaged in original shipping containers using Aeroflex packing molds. If original shipping containers and materials are not available, contact Aeroflex Customer Service for shipping instructions.

##### Freight Costs

All freight costs on non-warranty shipments are assumed by the customer. (See "Warranty Packet" for freight charge policy on warranty claims.)

### 1.2 REPACKING PROCEDURE

- Make sure bottom packing mold is seated on floor of shipping container.
- Carefully wrap Test Set with polyethylene sheeting to protect finish.
- Place Test Set into shipping container, making sure Test Set is securely seated in bottom packing mold.
- Place top packing mold over top of Test Set and press down until mold rests solidly in bottom packing mold.
- Close shipping container lids and seal with shipping tape or an industrial stapler. Tie all sides of container with break resistant rope, twine or equivalent.

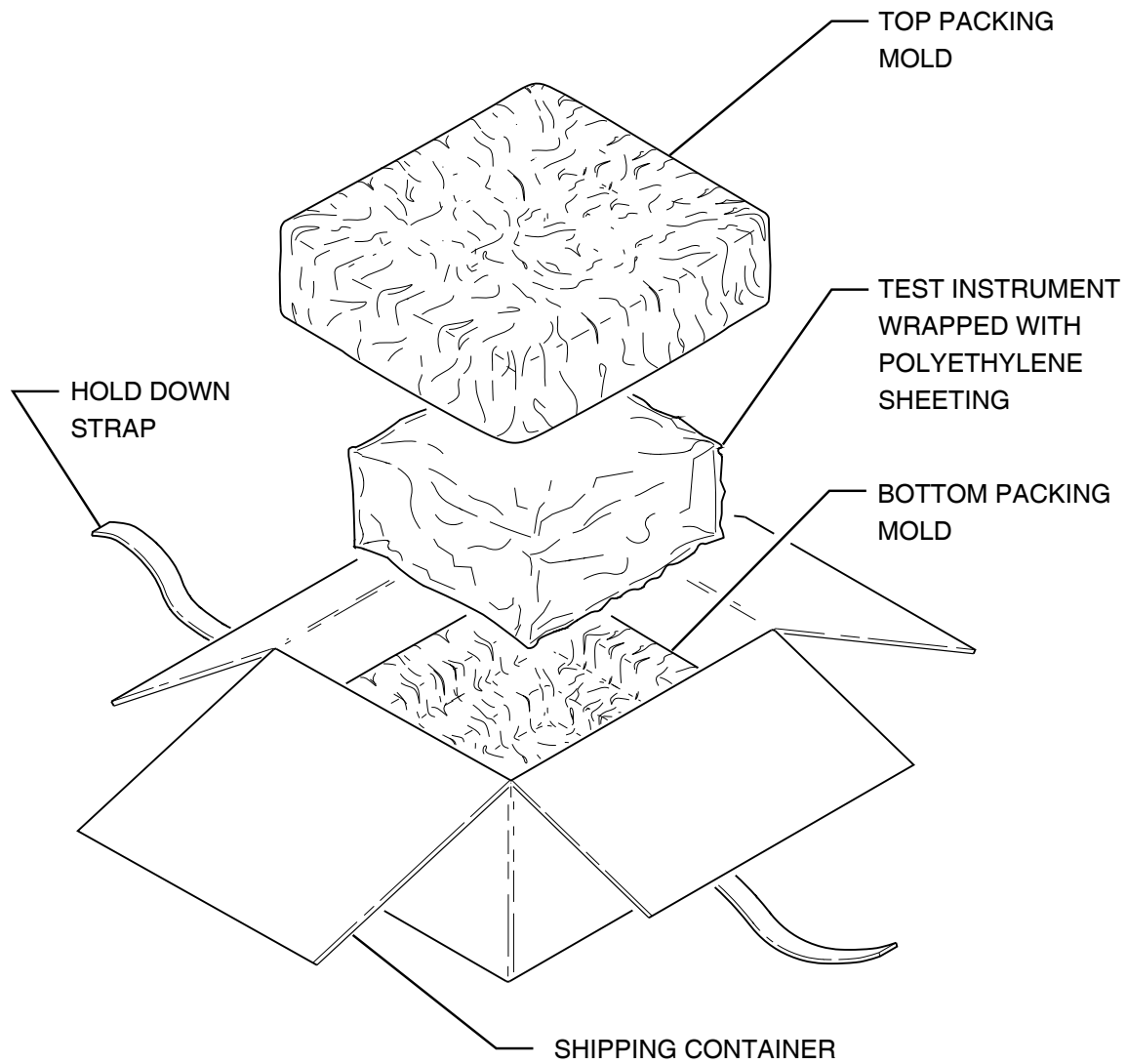

Repacking Procedure  
Figure 1

## SECTION 5 - STORAGE

### 1. STORING TEST SETS

Perform the following storage precautions whenever the Test Set is stored for extended periods:

- Disconnect Test Set from any electrical power source.
- Disconnect and store ac power cable and other accessories with Test Set.
- Cover Test Set to prevent dust and debris from covering and entering Test Set.



THIS PAGE INTENTIONALLY LEFT BLANK.

## APPENDIX A - CONNECTOR PIN-OUT TABLES

### 1. TABLE OF CONNECTORS

CONNECTOR	TYPE	SIGNAL	INPUT/OUTPUT
RF OUT	RF	TYPE N	OUTPUT
ARINC 429	See Pin-Out Table	10 PIN LEMO	INPUT/OUTPUT
SYNC	TTL	BNC	OUTPUT
VIDEO	VIDEO	BNC	OUTPUT
EXT RF	RF	BNC	INPUT
GPIB	See Pin-Out Table	IEEE 488/ANSI MC1.1	INPUT/OUTPUT

### 2. ARINC 429 BUS CONNECTOR PIN-OUT TABLE

PIN NO.	SIGNAL	TYPE	INPUT/OUTPUT
1	TX1A	RZ FORMAT	OUTPUT
2	TX1B	RZ FORMAT	OUTPUT
3	GND		
4	RX1A	RZ FORMAT	INPUT
5	RX1B	RZ FORMAT	INPUT
6	TX2A	RZ FORMAT	OUTPUT
7	TX2B	RZ FORMAT	OUTPUT
8	GND		
9	RX2A	RZ FORMAT	INPUT
10	RX2B	RZ FORMAT	INPUT

① LOW SPEED (12.5 kbps) 429 Transmit  
 ② LOW SPEED (12.5 kbps) 429 Receive  
 ③ HIGH SPEED (100 kbps) 429 Transmit  
 ④ HIGH SPEED (100 kbps) 429 Receive

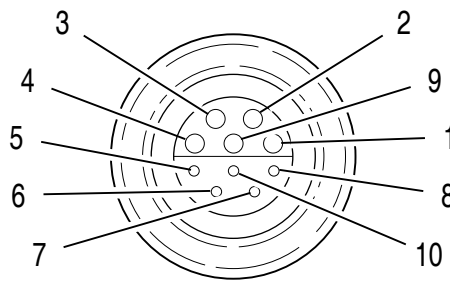

4818001

ARINC 429 BUS Connector  
Figure 1

### 3. GPIB CONNECTOR PIN-OUT TABLE

PIN NO.	SIGNAL	TYPE	INPUT/OUTPUT
1	D101	TTL	INPUT/OUTPUT
2	D102	TTL	INPUT/OUTPUT
3	D103	TTL	INPUT/OUTPUT
4	D104	TTL	INPUT/OUTPUT
5	EQ1	TTL	INPUT
6	DAV	TTL	INPUT/OUTPUT
7	NRFD	TTL	INPUT/OUTPUT
8	NDAC	TTL	INPUT/OUTPUT
9	IFC	TTL	INPUT
10	SRQ	TTL	OUTPUT
11	ATN	TTL	INPUT
12	GND		
13	D105	TTL	INPUT/OUTPUT
14	D106	TTL	INPUT/OUTPUT
15	D107	TTL	INPUT/OUTPUT
16	D108	TTL	INPUT/OUTPUT
17	REN	TTL	INPUT
18	PAIRED WITH 6	GND	
19	PAIRED WITH 7	GND	
20	PAIRED WITH 8	GND	
21	PAIRED WITH 9	GND	
22	PAIRED WITH 10	GND	
23	PAIRED WITH 11	GND	
24	GND		

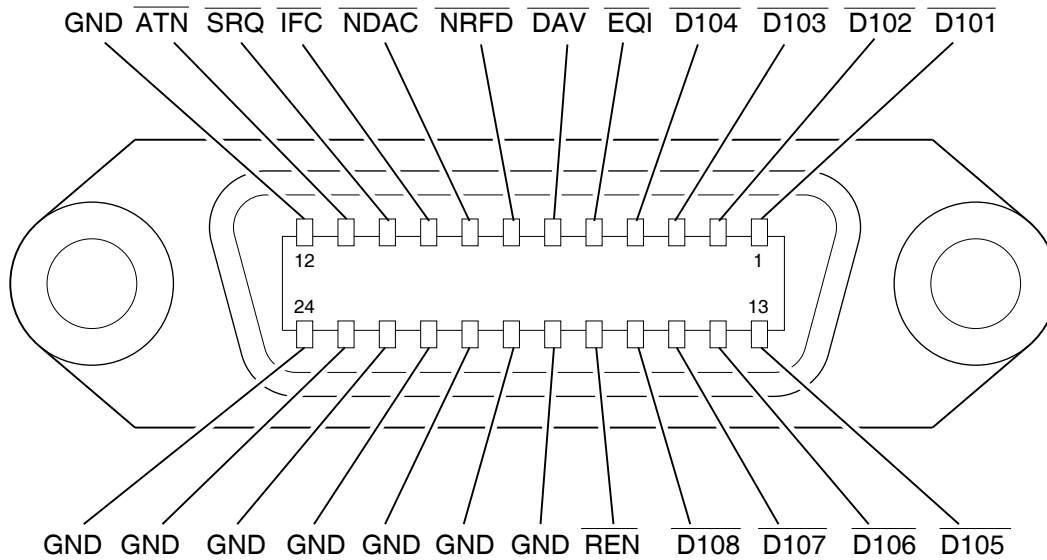

4818002



## APPENDIX B - MLS-800-2 TIMING SEQUENCES

### NORMAL AZ CYCLE

**NOTE:** If a function cable or data word is not enabled, the time reserved for that item becomes a delay.

Seq 1	Time (ms)	Seq 2	Time (ms)	Seq 1	Time (ms)	Seq 2	Time (ms)
ELEVATION	00.0	ELEVATION	65.9	ELEVATION	146.4	ELEVATION	230.2
HIGH RATE AZIMUTH	05.7	HIGH RATE AZIMUTH	71.7	HIGH RATE AZIMUTH	152.1	HIGH RATE AZIMUTH	235.9
DATA WORD #6	17.8	DATA WORD #2	83.7	TIME DELAY	164.1	DATA WORD #2	247.9
TIME DELAY	21.0	BACK AZIMUTH	86.9	TIME DELAY	167.3	BACK AZIMUTH	251.1
TIME DELAY	24.1	HIGH RATE AZIMUTH	98.9	TIME DELAY	170.5	HIGH RATE AZIMUTH	263.2
DATA WORD #1	27.2	ELEVATION	111.0	DATA WORD #4	173.6	ELEVATION	275.2
HIGH RATE AZIMUTH	30.4	HIGH RATE AZIMUTH	116.7	HIGH RATE AZIMUTH	176.8	HIGH RATE AZIMUTH	280.9
ELEVATION	42.4	ELEVATION	128.8	ELEVATION	188.8	ELEVATION	293.0
HIGH RATE AZIMUTH	48.1	TIME DELAY	134.5	HIGH RATE AZIMUTH	194.5	ELEVATION	298.7
ELEVATION	60.2	AUX WORD AD1	140.4	ELEVATION	206.6		
	65.9		146.4	TIME DELAY	212.3		
				TIME DELAY	218.2		
				AUX WORD AD2	224.2		
					230.2		

48MF001



Seq 1	Time (ms)	Seq 2	Time (ms)	Seq 1	Time (ms)	Seq 2	Time (ms)
ELEVATION	298.7	ELEVATION	382.5	ELEVATION	457.0	ELEVATION	522.9
HIGH RATE AZIMUTH	304.4	HIGH RATE AZIMUTH	388.2	HIGH RATE AZIMUTH	462.8	HIGH RATE AZIMUTH	528.6
DATA WORD #3	316.5	DATA WORD #2	400.3	TIME DELAY	474.8	DATA WORD #2	540.7
TIME DELAY	319.7	BACK AZIMUTH	403.5	TIME DELAY	477.9	BACK AZIMUTH	543.8
TIME DELAY	322.8	HIGH RATE AZIMUTH	415.5	TIME DELAY	481.0	HIGH RATE AZIMUTH	555.9
DATA WORD #1	325.9	ELEVATION	427.6	DATA WORD #5	484.2	ELEVATION	567.9
HIGH RATE AZIMUTH	329.1	HIGH RATE AZIMUTH	433.3	HIGH RATE AZIMUTH	487.3	HIGH RATE AZIMUTH	573.7
ELEVATION	341.1	ELEVATION	445.3	ELEVATION	499.4	ELEVATION	585.8
HIGH RATE AZIMUTH	346.9	TIME DELAY	451.0	HIGH RATE AZIMUTH	505.1	AUX WORD AD5 or AD6	591.4
ELEVATION	358.9		457.0	ELEVATION	517.2	TIME DELAY	597.3
TIME DELAY	364.6				522.9	AUX WORD AD4	603.4
TIME DELAY	370.6						609.3
AUX WORD AD3	376.5						
	382.5						

48MF002





**HIGH RATE AZ CYCLE**

**NOTE:** If a function cable or data word is not enabled, the time reserved for that item becomes a delay.

Seq 1	Time (ms)	Seq 2	Time (ms)	Seq 1	Time (ms)	Seq 2	Time (ms)
ELEVATION	00.0	ELEVATION	65.9	ELEVATION	146.4	ELEVATION	230.2
HIGH RATE AZIMUTH	05.7	HIGH RATE AZIMUTH	71.7	HIGH RATE AZIMUTH	152.1	HIGH RATE AZIMUTH	235.9
DATA WORD #6	17.8	DATA WORD #2	83.7	TIME DELAY	164.1	DATA WORD #2	247.9
TIME DELAY	21.0	BACK AZIMUTH	86.9	TIME DELAY	167.3	BACK AZIMUTH	251.1
TIME DELAY	24.1	HIGH RATE AZIMUTH	98.9	TIME DELAY	170.5	HIGH RATE AZIMUTH	263.2
DATA WORD #1	27.2	ELEVATION	111.0	DATA WORD #4	173.6	ELEVATION	275.2
HIGH RATE AZIMUTH	30.4	HIGH RATE AZIMUTH	116.7	HIGH RATE AZIMUTH	176.8	HIGH RATE AZIMUTH	280.9
ELEVATION	42.4	ELEVATION	128.8	ELEVATION	188.8	ELEVATION	293.0
HIGH RATE AZIMUTH	48.1	TIME DELAY	134.5	HIGH RATE AZIMUTH	194.5	ELEVATION	298.7
ELEVATION	60.2	AUX WORD AD1	140.4	ELEVATION	206.6		
	65.9		146.4	TIME DELAY	212.3		
				TIME DELAY	218.2		
				TIME DELAY	224.2		
				AUX WORD AD2	230.2		

48MF003



Seq 1	Time (ms)	Seq 2	Time (ms)	Seq 1	Time (ms)	Seq 2	Time (ms)
ELEVATION	298.7	ELEVATION	382.5	ELEVATION	457.0	ELEVATION	522.9
HIGH RATE AZIMUTH	304.4	HIGH RATE AZIMUTH	388.7	HIGH RATE AZIMUTH	462.8	HIGH RATE AZIMUTH	528.6
DATA WORD #3	316.5	DATA WORD #2	400.3	TIME DELAY	474.8	DATA WORD #2	540.7
TIME DELAY	319.7	BACK AZIMUTH	403.5	TIME DELAY	477.9	BACK AZIMUTH	543.8
TIME DELAY	322.8	HIGH RATE AZIMUTH	415.5	TIME DELAY	481.0	HIGH RATE AZIMUTH	555.9
DATA WORD #1	325.9	ELEVATION	427.6	DATA WORD #5	484.2	ELEVATION	567.9
HIGH RATE AZIMUTH	329.1	HIGH RATE AZIMUTH	433.3	HIGH RATE AZIMUTH	487.3	HIGH RATE AZIMUTH	573.7
ELEVATION	341.1	ELEVATION	445.3	ELEVATION	499.4	ELEVATION	585.8
HIGH RATE AZIMUTH	346.9	TIME DELAY	451.0	HIGH RATE AZIMUTH	505.1	AUX WORD AD5 or AD6	591.4
ELEVATION	358.9		457.0	ELEVATION	517.2	TIME DELAY	597.3
TIME DELAY	364.6				522.9	AUX WORD AD4	603.4
TIME DELAY	370.6						609.3
AUX WORD AD3	376.5						
	382.5						

48MF004



**APPENDIX C - CHANNEL FREQUENCIES**

MLS CHANNEL	DME CHANNEL	RF	IF	VCO	VCO + 4
500	18X	5031.00	4281.00	856.200	214.050
501	18Y	5031.30	4281.30	856.260	214.065
502	20X	5031.60	4281.60	856.320	214.080
503	20Y	5031.90	4281.90	856.380	214.095
504	22X	5032.20	4282.20	856.440	214.110
505	22W	5032.50	4282.50	856.500	214.125
506	24X	5032.80	4282.80	856.560	214.140
507	24W	5033.10	4283.10	856.620	214.155
508	26X	5033.40	4283.40	856.680	214.170
509	26W	5033.70	4283.70	856.740	214.185
510	28X	5034.00	4284.00	856.800	214.200
511	28W	5034.30	4284.30	856.860	214.215
512	30X	5034.60	4284.60	856.920	214.230
513	30W	5034.90	4284.90	856.980	214.245
514	32X	5035.20	4285.20	857.040	214.260
515	32W	5035.50	4285.50	857.100	214.275
516	34X	5035.80	4285.80	857.160	214.290
517	34W	5036.10	4286.10	857.220	214.305
518	36X	5036.40	4286.40	857.280	214.320
519	36W	5036.70	4286.70	857.340	214.335
520	38X	5037.00	4287.00	857.400	214.350
521	38W	5037.30	4287.30	857.460	214.365
522	40X	5037.60	4287.60	857.520	214.380
523	40W	5037.90	4287.90	857.580	214.395
524	42X	5038.20	4288.20	857.640	214.410
525	42W	5038.50	4288.50	857.700	214.425
526	44X	5038.80	4288.80	857.760	214.440
527	44W	5039.10	4289.10	857.820	214.455
528	46X	5039.40	4289.40	857.880	214.470
529	46W	5039.70	4289.70	857.940	214.485
530	48X	5040.00	4290.00	858.000	214.500
531	48W	5040.30	4290.30	858.060	214.515
532	50X	5040.60	4290.60	858.120	214.530
533	50W	5040.90	4290.90	858.180	214.545
534	52X	5041.20	4291.20	858.240	214.560
535	52W	5041.50	4291.50	858.300	214.575
536	54X	5041.80	4291.80	858.360	214.590
537	54W	5042.10	4292.10	858.420	214.605
538	56X	5042.40	4292.40	858.480	214.620
539	56W	5042.70	4292.70	858.540	214.635
540	17Y	5043.00	4293.00	858.600	214.650
541	17Z	5043.30	4293.30	858.660	214.665
542	18Y	5043.60	4293.60	858.720	214.680
543	18Z	5043.90	4293.90	858.780	214.695
544	19Y	5044.20	4294.20	858.840	214.710



MLS CHANNEL	DME CHANNEL	RF	IF	VCO	VCO + 4
545	19Z	5044.50	4294.50	858.900	214.725
546	20Y	5044.80	4294.80	858.960	214.740
547	20Z	5045.10	4295.10	859.020	214.755
548	21Y	5045.40	4295.40	859.080	214.770
549	21Z	5045.70	4295.70	859.140	214.785
550	22Y	5046.00	4296.00	859.200	214.800
551	22Z	5046.30	4296.30	859.260	214.815
552	23Y	5046.60	4296.60	859.320	214.830
553	23Z	5046.90	4296.90	859.380	214.845
554	24Y	5047.20	4297.20	859.440	214.860
555	24Z	5047.50	4297.50	859.500	214.875
556	25Y	5047.80	4297.80	859.560	214.890
557	25Z	5048.10	4298.10	859.620	214.905
558	26Y	5048.40	4298.40	859.680	214.820
559	26Z	5048.70	4298.70	859.740	214.935
560	27Y	5049.00	4299.00	859.800	214.950
561	27Z	5049.30	4299.30	859.860	214.965
562	28Y	5049.60	4299.60	859.920	214.980
563	28Z	5049.90	4299.90	859.980	214.995
564	29Y	5050.20	4300.20	860.040	215.010
565	29Z	5050.50	4300.50	860.100	215.025
566	30Y	5050.80	4300.80	860.160	215.040
567	30Z	5051.10	4301.10	860.220	215.055
568	31Y	5051.40	4301.40	860.280	215.070
569	31Z	5051.70	4301.70	860.340	215.085
570	32Y	5052.00	4302.00	860.400	215.100
571	32Z	5052.30	4302.30	860.460	215.115
572	33Y	5052.60	4302.60	860.520	215.130
573	33Z	5052.90	4302.90	860.580	215.145
574	34Y	5053.20	4303.20	860.640	215.160
575	34Z	5053.50	4303.50	860.700	215.175
576	35Y	5053.80	4303.80	860.760	215.190
577	35Z	5054.10	4304.10	860.820	215.205
578	36Y	5054.40	4304.40	860.880	215.220
579	36Z	5054.70	4304.70	860.940	215.235
580	37Y	5055.00	4305.00	861.000	215.250
581	37Z	5055.30	4305.30	861.060	215.265
582	38Y	5055.60	4305.60	861.120	215.280
583	38Z	5055.90	4305.90	861.180	215.295
584	39Y	5056.20	4306.20	861.240	215.310
585	39Z	5056.50	4306.50	861.300	215.325
586	40Y	5056.80	4306.80	861.360	215.340
587	40Z	5057.10	4307.10	861.420	215.355
588	41Y	5057.40	4307.40	861.480	215.370
589	41Z	5057.70	4307.70	861.540	215.385



MLS CHANNEL	DME CHANNEL	RF	IF	VCO	VCO + 4
590	42Y	5058.00	4308.00	861.600	215.400
591	42Z	5058.30	4308.30	861.660	215.415
592	43Y	5058.60	4308.60	861.720	215.430
593	43Z	5058.90	4308.90	861.780	215.445
594	44Y	5059.20	4309.20	861.840	215.460
595	44Z	5059.50	4309.50	861.900	215.475
596	45Y	5059.80	4309.80	861.960	215.490
597	45Z	5060.10	4310.10	862.020	215.505
598	46Y	5060.40	4310.40	862.080	215.520
599	46Z	5060.70	4310.70	862.140	215.535
600	47Y	5061.00	4311.00	862.200	215.550
601	47Z	5061.30	4311.30	862.260	215.565
602	48Y	5061.60	4311.60	862.320	215.580
603	48Z	5061.90	4311.90	862.380	215.595
604	49Y	5062.20	4312.20	862.440	215.610
605	49Z	5062.50	4312.50	862.500	215.625
606	50Y	5062.80	4312.80	862.560	215.640
607	50Z	5063.10	4313.10	862.620	215.655
608	51Y	5063.40	4313.40	862.680	215.670
609	51Z	5063.70	4313.70	862.740	215.685
610	52Y	5064.00	4314.00	862.800	215.700
611	52Z	5064.30	4314.30	862.860	215.715
612	53Y	5064.60	4314.60	862.920	215.730
613	53Z	5064.90	4314.90	862.980	215.745
614	54Y	5065.20	4315.20	863.040	215.760
615	54Z	5065.50	4315.50	863.100	215.775
616	55Y	5065.80	4315.80	863.160	215.790
617	55Z	5066.10	4316.10	863.220	215.805
618	56Y	5066.40	4316.40	863.280	215.820
619	56Z	5066.70	4316.70	863.340	215.835
620	80Y	5067.00	4317.00	863.400	215.850
621	80Z	5067.30	4317.30	863.460	215.865
622	81Y	5067.60	4317.60	863.520	215.880
623	81Z	5067.90	4317.90	863.580	215.895
624	82Y	5068.20	4318.20	863.640	215.910
625	82Z	5068.50	4318.50	863.700	215.925
626	83Y	5068.80	4318.80	863.760	215.940
627	83Z	5069.10	4319.10	863.820	215.955
628	84Y	5069.40	4319.40	863.880	215.970
629	84Z	5069.70	4319.70	863.940	215.985
630	85Y	5070.00	4320.00	864.000	216.000
631	85Z	5070.30	4320.30	864.060	216.015
632	86Y	5070.60	4320.60	864.120	216.030
633	86Z	5070.90	4320.90	864.180	216.045
634	87Y	5071.20	4321.20	864.240	216.060



MLS CHANNEL	DME CHANNEL	RF	IF	VCO	VCO + 4
635	87Z	5071.50	4321.50	864.300	216.075
636	88Y	5071.80	4321.80	864.360	216.090
637	88Z	5072.10	4322.10	864.420	216.105
638	89Y	5072.40	4322.40	864.480	216.120
639	89Z	5072.70	4322.70	864.540	216.135
640	90Y	5073.00	4323.00	864.600	216.150
641	90Z	5073.30	4323.30	864.660	216.165
642	91Y	5073.60	4323.60	864.720	216.180
643	91Z	5073.90	4323.90	864.780	216.195
644	92Y	5074.20	4324.20	864.840	216.210
645	92Z	5074.50	4324.50	864.900	216.225
646	93Y	5074.80	4324.80	864.960	216.240
647	93Z	5075.10	4325.10	865.020	216.255
648	94Y	5075.40	4325.40	865.080	216.270
649	94Z	5075.70	4325.70	865.140	216.285
650	95Y	5076.00	4326.00	865.200	216.300
651	95Z	5076.30	4326.30	865.260	216.315
652	96Y	5076.60	4326.60	865.320	216.330
653	96Z	5076.90	4326.90	865.380	216.345
654	97Y	5077.20	4327.20	865.440	216.360
655	97Z	5077.50	4327.50	865.500	216.375
656	98Y	5077.80	4327.80	865.560	216.390
657	98Z	5078.10	4328.10	865.620	216.405
658	99Y	5078.40	4328.40	865.680	216.420
659	99Z	5078.70	4328.70	865.740	216.435
660	100Y	5079.00	4329.00	865.800	216.450
661	100Z	5079.30	4329.30	865.860	216.465
662	101Y	5079.60	4329.60	865.920	216.480
663	101Z	5079.90	4329.90	865.980	216.495
664	102Y	5080.20	4330.20	866.040	216.510
665	102Z	5080.50	4330.50	866.100	216.525
666	103Y	5080.80	4330.80	866.160	216.540
667	103Z	5081.10	4331.10	866.220	216.555
668	104Y	5081.40	4331.40	866.280	216.570
669	104Z	5081.70	4331.70	866.340	216.585
670	105Y	5082.00	4332.00	866.400	216.600
671	105Z	5082.30	4332.30	866.460	216.615
672	106Y	5082.60	4332.60	866.520	216.630
673	106Z	5082.90	4332.90	866.580	216.645
674	107Y	5083.20	4333.20	866.640	216.660
675	107Z	5083.50	4333.50	866.700	216.675
676	108Y	5083.80	4333.80	866.760	216.690
677	108Z	5084.10	4334.10	866.820	216.705
678	109Y	5084.40	4334.40	866.880	216.720
679	109Z	5084.70	4334.70	866.940	216.735



MLS CHANNEL	DME CHANNEL	RF	IF	VCO	VCO + 4
680	110Y	5085.00	4335.00	867.000	216.750
681	110Z	5085.30	4335.30	867.060	216.765
682	111Y	5085.60	4335.60	867.120	216.780
683	111Z	5085.90	4335.90	867.180	216.795
684	112Y	5086.20	4336.20	867.240	216.810
685	112Z	5086.50	4336.50	867.300	216.825
686	113Y	5086.80	4336.80	867.360	216.840
687	113Z	5087.10	4337.10	867.420	216.855
688	114Y	5087.40	4337.40	867.480	216.870
689	114Z	5087.70	4337.70	867.540	216.885
690	115Y	5088.00	4338.00	867.600	216.900
691	115Z	5088.30	4338.30	867.660	216.915
692	116Y	5088.60	4338.60	867.720	216.930
693	116Z	5088.90	4338.90	867.780	216.945
694	117Y	5089.20	4339.20	867.840	216.960
695	117Z	5089.50	4339.50	867.900	216.975
696	118Y	5089.80	4339.80	867.960	216.990
697	118Z	5090.10	4340.10	868.020	217.005
698	119Y	5090.40	4340.40	868.080	217.020
699	119Z	5090.70	4340.70	868.140	217.035



THIS PAGE INTENTIONALLY LEFT BLANK.



## APPENDIX D - PFE AND CMN FILTER DEFINITIONS

GUIDANCE FUNCTION	CORNER FREQUENCIES (RADIAN/SEC)		
	W0	W1	W2
APPROACH AZIMUTH	0.5	0.3	10
BACK AZIMUTH	0.5	0.3	10
APPROACH ELEVATION	1.5	0.5	10
FLARE	2.0	0.5	10

Filter Definitions  
Table 1

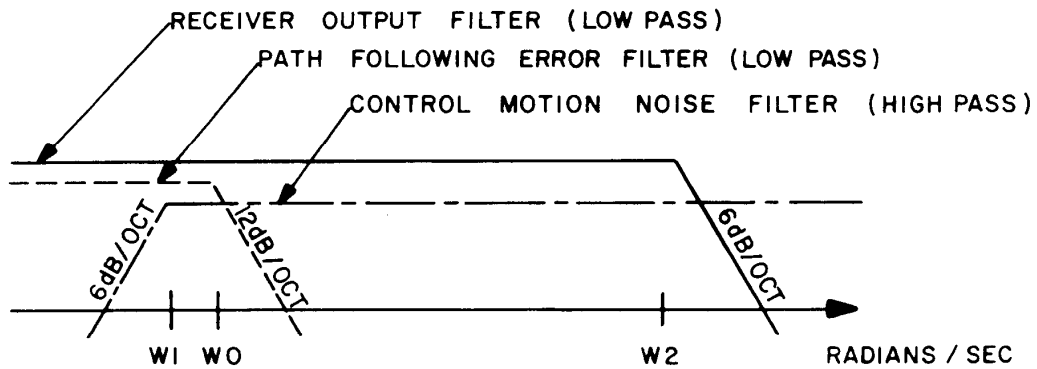

Filter Definitions  
Table 1



THIS PAGE INTENTIONALLY LEFT BLANK.



**APPENDIX E - METRIC/BRITISH IMPERIAL CONVERSION TABLE  
WITH NAUTICAL DISTANCE CONVERSIONS**

<b>TO CONVERT:</b>	<b>INTO:</b>	<b>MULTIPLY BY:</b>	<b>TO CONVERT:</b>	<b>INTO:</b>	<b>MULTIPLY BY:</b>
cm	feet	0.03281	meters	feet	3.281
cm	inches	0.3937	meters	inches	39.37
feet	cm	30.48	m/sec	ft/sec	3.281
feet	meters	0.3048	m/sec	km/hr	3.6
ft/sec	km/hr	1.097	m/sec	miles/hr	2.237
ft/sec	knots	0.5921	miles	feet	5280
ft/sec	miles/hr	0.6818	miles	km	1.609
ft/sec <sup>2</sup>	cm/sec <sup>2</sup>	30.48	miles	meters	1609
ft/sec <sup>2</sup>	m/sec <sup>2</sup>	0.3048	miles	nmi	0.8684
grams	ounces	0.03527	miles/hr	ft/sec	1.467
inches	cm	2.54	miles/hr	km/hr	1.609
kg	pounds	2.205	miles/hr	knots	0.8684
kg/cm <sup>2</sup>	psi	0.0703	nmi	feet	6080.27
km	feet	3281	nmi	km	1.8532
km	miles	0.6214	nmi	meters	1853.2
km	nmi	0.5396	nmi	miles	1.1516
km/hr	ft/sec	0.9113	ounces	grams	28.34953
km/hr	knots	0.5396	pounds	kg	0.4536
km/hr	miles/hr	0.6214	psi	kg/cm <sup>2</sup>	0.0703
knots	ft/sec	1.689	100 ft	km	3.048
knots	km/hr	1.8532	100 ft	miles	1.894
knots	miles/hr	1.1516	100 ft	nmi	1.645



THIS PAGE INTENTIONALLY LEFT BLANK.

**APPENDIX F - AUXILIARY EQUIPMENT**

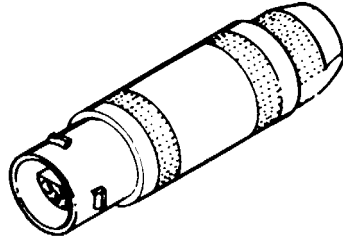

429 Terminator  
Figure 1

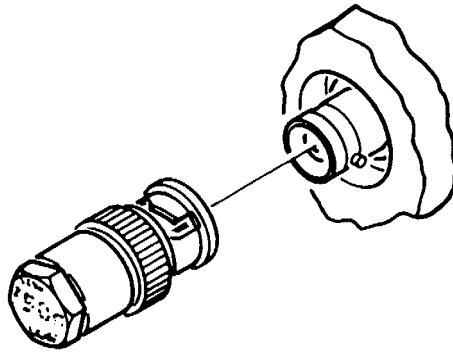

50  $\Omega$  Load  
Figure 2



THIS PAGE INTENTIONALLY LEFT BLANK.

## APPENDIX G - MLS-800-2 APPROACH AZIMUTH BEAM BOARD DATA

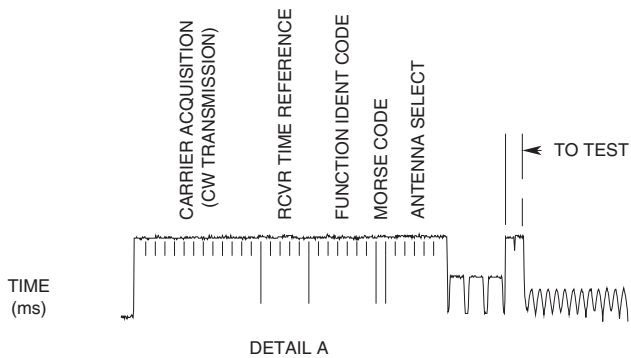
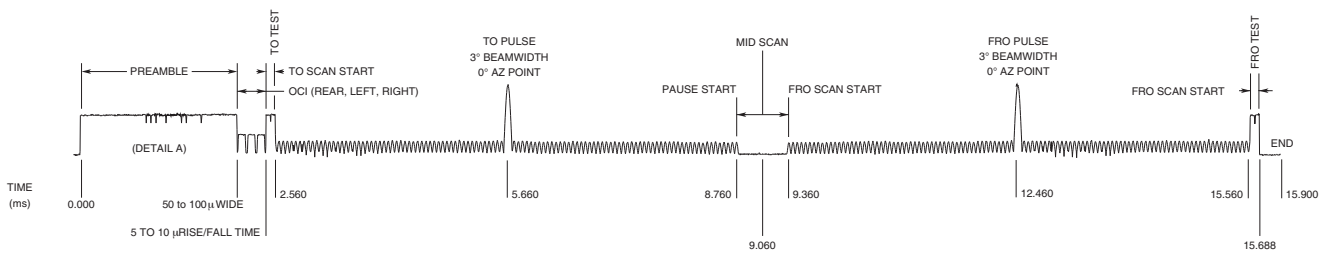

4814009



THIS PAGE INTENTIONALLY LEFT BLANK.



## APPENDIX H - ABBREVIATIONS

<b>A</b>		<b>H</b>	
A	Ampere	HiAZ	High Rate Azimuth
ALT MM	Alternate Main Path and Multipath	Hz	Hertz
Ant	Antenna		<b>I</b>
ARINC	Aeronautical Research Inc.	IA	Initial Approach
ASCII	American National Standard Code for Information Interchange	IF	International Civil Aviation Organization
AUX	Auxiliary		<b>K</b>
AZ	Azimuth	kbps	Kilobytes per Second
	<b>B</b>	kHz	Kilohertz
BATT	Battery		<b>L</b>
BAZ	Back Azimuth	LT	Left
	<b>C</b>		<b>M</b>
ccw	Counterclockwise	M	Meter
CHNL	Channel	MHz	Megahertz
Clr	Clearance	Min	Minimum
CMN	Control Motion Noise	MLSTEST	Test Operational Menu
Cov	Coverage	MP	Multipath
CRT	Cathode Ray Tube		<b>N</b>
cw	Clockwise	Neg	Negative
	<b>D</b>		<b>O</b>
dB	Decibel	OCI	Out of Coverage Indicator
dBc	Decibel Relative to Carrier Value	OE	Odd-Even
dBm	Decibels Relative to Milliwatts	OO	Odd-Odd
Deg	Degree	OUT	Output
DIAG	Diagnostic		<b>P</b>
DME	Distance Measuring Equipment	PFE	Path Following Error
DMEP	Precision Distance Measurement Equipment	PFN	Path Following Noise
DPSK	Differential Phase Shift Keying	Pos	Positive
	<b>E</b>	Prop	Proportional
EE	Even-Even	PWR	Power
EL	Elevation		<b>R</b>
EO	Even-Odd	RAM	Random Access Memory
	<b>F</b>	RCVR	Receiver
FA	Final Approach	RF	Radio Frequency
FL	Flare	ROM	Read Only Memory
	<b>G</b>	RR	Rear
		RST	Reset
		RT	Right
GPIB	General Purpose Interface Bus		

**S**

SAVEDIR	Save Page Directory
SDI	Source Designation Identifier
SEC	Second
Sig	Signal
SP FUN	Special Function
SRQ	Service Request
SSM	Sign Status Matrix
SYS	System

**T**

TDM	Time Division Multiplex
Thresh	Threshold
TTL	Transistor-Transistor Logic

**U**

UUT	Unit Under Test
-----	-----------------

**V**

V	Volt
VAC	Volts Alternating Current
Vdc	Volts Direct Current

**W**

WE	Word Error
W PROT	Write Protect

## INDEX

Abbreviations	App H	Performance Evaluation	1-2-4, p 1
Alphabetical Quick Reference ASCII Command Table	1-2-6, p 7	PFE and CMN Filter Definitions	App D, p 1
Auxiliary Equipment	App F	Power Up Self Test	
Auxiliary Data Words Parity Combinations	1-2-3, p 20	Menu Definition	1-2-3, p 1
		Performance Evaluation	1-2-4, p 1
Connector Pin-Out Tables		Ramp Test Installation and Procedure	1-2-1, p 2
ARINC 429 Bus Connector	App A, p 1	Remote Operation	1-2-6, p 1
GPIB Connector	App A, p 2	ASCII Output Command Data Format	1-2-6, p 5
Table of Connectors	App A, p 1	ASCII Output Commands to MLS-800-2	1-2-6, p 5
Controls, Connectors and Indicators		Command and Data Structure	1-2-6, p 5
Front Panel	1-2-2, p 3	Command Groups	1-2-6, p 6
Rear Panel	1-2-2, p 5	GPIB Transactions	1-2-6, p 1
Channel Frequencies	App C	Reply Identifier	1-2-6, p 6
		Return Data Format	1-2-6, p 6
Description	1-1-1, p 1	Repacking Procedure	1-4-1, p 1
Diagnostic Menu	1-2-3, p 22		
Definition	1-2-5, p 6	Safety Precautions	1-2-1, p 1
Operation		Save Page Directory Menu	1-2-3, p 3
429 Loop Test	1-2-5, p 8	Shipping	1-4-1, p 1
CRT Alignment Test	1-2-3, p 7	Shipping Information	1-4-1, p 1
RF Channel Test	1-2-3, p 8	Special Functions Menu	1-2-3, p 25
Functional Capabilities	1-1-1, p 1	Specifications	
		Additional Functions	1-3-1, p 5
General Description and Capabilities	1-1-1, p 1	Modulation	1-3-1, p 2
		Power	1-3-1, p 6
Installation	1-2-1, p 1	RF Signal Generator	1-3-1, p 1
Installation and Operating Precautions	1-2-1, p 2	Standard Test Conditions	1-2-5, p 5
		Status and Service Request	
Keyboard Operating Procedures	1-2-5, p 1	Transactions	1-2-6, p 2
DATA ENTRY and DATA SLEW Keys	1-2-5, p 1	Storage	1-5-1, p 1
Delete Data Page	1-2-3, p 3		
Purge Data Page	1-2-3, p 2	Test Operational Menu	1-2-3, p 4
Recall Data Page	1-2-3, p 1	Auxiliary Data Word A1	1-2-3, p 14
Save Data Page	1-2-3, p 2	Auxiliary Data Word A2	1-2-3, p 15
SYNC Function	1-2-3, p 4	Auxiliary Data Word A3	1-2-3, p 16
Write Protect Data Page	1-2-3, p 3	Auxiliary Data Word A4	1-2-3, p 17
		Auxiliary Data Word A5	1-2-3, p 18
Master Menu	1-2-3, p 2	Auxiliary Data Word A6	1-2-3, p 19
Menu Definition	1-2-3, p 1	Data Word #1	1-2-3, p 8
Diagnostic Menu	1-2-3, p 22	Data Word #2	1-2-3, p 9
Master Menu	1-2-3, p 1	Data Word #3	1-2-3, p 10
Power Up Self Test Menu	1-2-3, p 2	Data Word #4	1-2-3, p 11
Save Page Directory Menu	1-2-3, p 3	Data Word #5	1-2-3, p 12
Special Function Menu	1-2-3, p 25	Data Word #6	1-2-3, p 13
Test Operational Menu	1-2-3, p 4		
Metric/British Conversion Table	App E, p 1		
MLS-800-2 Approach Azimuth Beam Board Data	App G		
MLS-800-2 Command Set	1-2-6, p 10		
MLS-800-2 System Interface Installation	1-2-1, p 2		
MLS-800-2 Timing Sequences			
High Rate AZ Cycle	App B, p 3		
Normal AZ Cycle	App B, p 1		
Operating Procedures	1-2-5, p 1		
Operating Precautions, Installation and	1-2-1, p 2		



THIS PAGE INTENTIONALLY LEFT BLANK

As we are always seeking to improve our products, the information in this document gives only a general indication of the product capacity, performance and suitability, none of which shall form part of any contract. We reserve the right to make design changes without notice.

CHINA / Beijing	Tel: [+86] (10) 6539 1166	Fax: [+86] (10) 6539 1778
CHINA / Shanghai	Tel: [+86] (21) 5109 5128	Fax: [+86] (21) 5150 6112
FINLAND	Tel: [+358] (9) 2709 5541	Fax: [+358] (9) 804 2441
FRANCE	Tel: [+33] 1 60 79 96 00	Fax: [+33] 1 60 77 69 22
GERMANY	Tel: [+49] 8131 2926-0	Fax: [+49] 8131 2926-130
HONG KONG	Tel: [+852] 2832 7988	Fax: [+852] 2834 5364
INDIA	Tel: [+91] 80 51150 4501	Fax: [+91] 80 5115 4502
KOREA	Tel: [+82] (2) 3424 2719	Fax: [+82] (2) 3424 8620
SCANDINAVIA	Tel: [+45] 9614 0045	Fax: [+45] 9614 0047
SPAIN	Tel: [+34] (91) 640 11 34	Fax: [+34] (91) 640 06 40
UK / Burnham	Tel: [+44] (0) 1628 604455	Fax: [+44] (0) 1628 662017
UK / Cambridge	Tel: [+44] (0) 1763 262277	Fax: [+44] (0) 1763 285353
UK / Stevenage	Tel: [+44] (0) 1438 742200	Fax: [+44] (0) 1438 727601
	Freephone: 0800 282388	
USA	Tel: [+1] (316) 522 4981	Fax: [+1] (316) 522 1360
	Toll Free: 800 835 2352	

**EXPORT CONTROL WARNING:** This document contains controlled technology or technical data under the jurisdiction of the Export Administration Regulations (EAR), 15 CFR 730-774. It cannot be transferred to any foreign third party without the specific prior approval of the U.S. Department of Commerce Bureau of Industry and Security (BIS). Violations of these regulations are punishable by fine, imprisonment, or both.

The logo for AEROFLEX, featuring a stylized 'A' with a blue triangle inside, followed by the word 'AEROFLEX' in a bold, sans-serif font. The logo is positioned within a large, light blue curved shape that sweeps across the bottom right of the page.

Our passion for performance is defined by three attributes represented by these three icons: solution-minded, performance-driven, customer-focused.